

GAC03S05

DC-DC Converter Technical Manual V1.0

Date: 2011-02-20



Nonstandard-Brick DC-DC Converter	36–75 V Input	5 V Output	3 A Current	Negative Logic
--	--------------------------	-----------------------	------------------------	---------------------------

Description

The GAC03S05 is an isolated DC-DC converter that uses an industry nonstandard-brick structure, and features high efficiency and power density. It has the dimensions of 10.5 mm x 25.4 mm x 50.8 mm (0.41 in. x 1.00 in. x 2.00 in.) and provides the rated output voltage of 5 V and the maximum output current of 3 A.

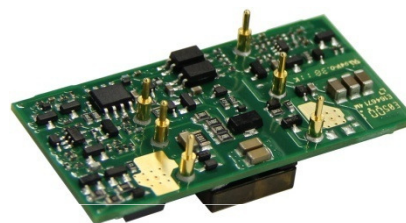

GAC03S05

Operational Features

- Input voltage: 36–75 V
- Output current: 0–3 A
- Low output ripple and noise
- Efficiency: 88% (5 V, 3 A)

Mechanical Features

- Industry nonstandard-brick (H x W x D): 10.5 mm x 25.4 mm x 50.8 mm (0.41 in. x 1.00 in. x 2.00 in.)
- Weight: about 30 g

Control Features

- Remote on/off
- Output voltage trim

Protection Features

- Input undervoltage protection
- Output overcurrent protection (hiccup mode)
- Output short circuit protection (hiccup mode)
- Output overvoltage protection (hiccup mode)

Safety Features

- UL60950-1 and IEC/EN60950
- Underwriters Laboratory (UL) certification
- Class A requirements in FCC and EN55022 (after connecting to an external filtering circuit)
- UL94V-0
- Restriction of the use of certain hazardous substance (RoHS) 6

Mechanical Diagram

Unit of measurement: mm (in.)

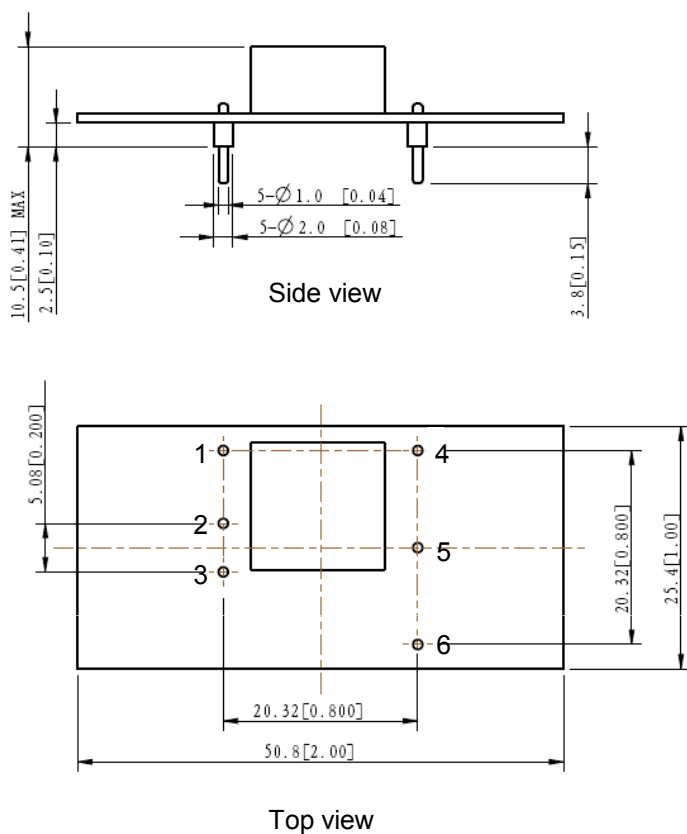

Pin description

Pin No.	Function
1	CNT
2	$V_{in} (-)$
3	$V_{in} (+)$
4	$V_{out} (-)$
5	Trim
6	$V_{out} (+)$

Dimensions tolerance

.x	± 0.2 mm (0.008 in.)
.xx	± 0.13 mm (0.005 in.)

Designation Explanation

G A C 03 S 05
 1 2 3 4 5 6

- 1 — Isolated
- 2 — Analog
- 3 — Eighth brick
- 4 — Output current: 3 A
- 5 — Single output
- 6 — Output voltage: 5 V

Electrical Specifications

Conditions: $T_A = 25^\circ\text{C}$ (77°F), Airflow = 1.0 m/s (200 LFM), $V_{in} = 48\text{ V}$, $V_{out} = 5\text{ V}$, unless otherwise specified.

Parameter	Min.	Typ.	Max.	Units	Remarks
Absolute maximum ratings					
Input voltage					
Continuous	-	-	80	V	-
Transient (100 ms)	-	-	100	V	-
Operating ambient temperature	-40	-	75	°C	See the thermal derating curve.
Storage temperature	-55	-	125	°C	-
Operating humidity	10	-	95	% RH	Non-condensing
Input characteristics					
Operating input voltage	36	48	75	V	$I_{out} = 1.5\text{ A}$
Maximum input current	-	-	0.8	A	$V_{in} = 0\text{--}75\text{ V}$; $I_{out} = 3\text{ A}$
No-load loss	-	0.69	-	W	$V_{in} = 48\text{ V}$
Input capacitance	100	-	-	μF	Electrolytic capacitor
Inrush transient	-	-	1	A ² s	-
Input reflected ripple current	-	-	30	mAp-p	-
Output characteristics					
Output voltage setpoint accuracy	4.95	5	5.05	V	-
Output power	0	-	15	W	-
Output line regulation	-	0.02	0.20	%Vo	-
Output load regulation	-	0.02	0.50	%Vo	-
Regulated voltage precision	-3	-	3	%Vo	The whole range of V_{in} , I_{out} and T_A
Temperature coefficient	-	-	0.02	%Vo/°C	$T_A = -40^\circ\text{C}$ to $+85^\circ\text{C}$ (-40°F to $+185^\circ\text{F}$)
External capacitance	0	220	1000	μF	Electrolytic capacitor
Output current	0	-	3	A	-
Output ripple and noise	-	15	100	mVp-p	Oscilloscope bandwidth: 20 MHz
Output voltage adjustment range(trim)	90	-	110	%Vo	-
Out voltage overshoot	-	-	5	%Vo	The whole range of V_{in} , I_{out} and T_A
Output voltage rise time	-	8.5	20	ms	The whole range of V_{in} , I_{out} and T_A
Switching frequency	-	260	-	kHz	-

Electrical Specifications

Conditions: $T_A = 25^\circ\text{C}$ (77°F), Airflow = 1.0 m/s (200 LFM), $V_{in} = 48\text{ V}$, $V_{out} = 5\text{ V}$, unless otherwise specified.

Parameter	Min.	Typ.	Max.	Units	Remarks
Protection Features					
Input undervoltage protection					
Startup threshold	32	34.2	36	V	-
Shutdown threshold	30	32.3	35	V	-
Hysteresis	1	-	3	V	-
Output overcurrent protection	3.3	-	5.1	A	$V_{in} = 36\text{-}75\text{ V}$; Hiccup mode
Output short circuit protection	-	-	-	-	Hiccup mode
Output overvoltage protection	5.6	-	7.0	V	Hiccup mode
Dynamic Characteristics					
Overshoot amplitude	-	84	250	mV	Current change rate: 0.1 A/ μs load : 25%–50%–25%; 50%–75%–50%
Recovery time	-	0	200	μs	
Efficiency					
100% load	-	88.0	-	%	$V_{in} = 48\text{ V}$; $I_{out} = 3\text{ A}$; $T_A = 25^\circ\text{C}$ (77°F)
50% load	-	85.9	-	%	$V_{in} = 48\text{ V}$; $I_{out} = 1.5\text{ A}$; $T_A = 25^\circ\text{C}$ (77°F)
20% load	-	77.6	-	%	$V_{in} = 48\text{ V}$; $I_{out} = 0.6\text{ A}$; $T_A = 25^\circ\text{C}$ (77°F)
Isolation characteristics					
Input-to-output Isolation voltage	-	1500	-	V DC	Functional Isolation
Other features					
Remote on/off voltage					
Low level	-0.7	-	1.2	V	-
High level	3.5	-	12	V	-
On/Off current					
Low level	-	-	1.0	mA	-
High level	-	-	1.0	mA	-
Reliability characteristics					
Mean time between failures (MTBF)	-	1.5	-	Million hours	Airflow = 1.5 m/s (300 LFM); $T_A = 40^\circ\text{C}$ (104° F); 80% load; Telcordia SR332 Method 1 case 3

Qualification Testing

Parameter	Units	Condition
High Accelerated Life Test (HALT)	4	Lower operating limit: -60°C (-76°F); upper operating limit: 120°C (248°F); destruct limit: 40 G
Thermal Shock	32	500 temperature cycles between -40°C (-40°F) and $+125^{\circ}\text{C}$ ($+257^{\circ}\text{F}$) with the temperature change rate of 20°C (68°F) per minute Lasting for 30 minutes both at -40°C (-40°F) and $+125^{\circ}\text{C}$ ($+257^{\circ}\text{F}$)
Temperature Humidity Bias	16	85°C (185°F); 85% RH; no load; operating 1000 hours
High Temperature Operation Life (HTOL)	16	Rated input voltage; air flow: 2.0 m/s(400 LFM); ambient temperature: 50°C (122°F); operating 1000 hours under 50%–80% load

Characteristic Curves

Figure 1: Efficiency
($T_A = 25^{\circ}\text{C}$ or 77°F)

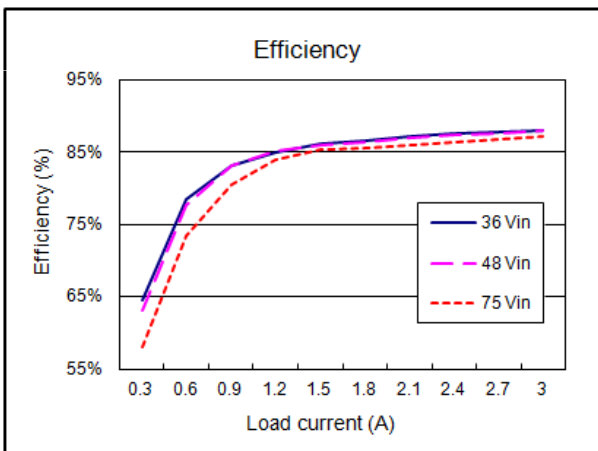

Figure 2: Power dissipation
($T_A = 25^{\circ}\text{C}$ or 77°F)

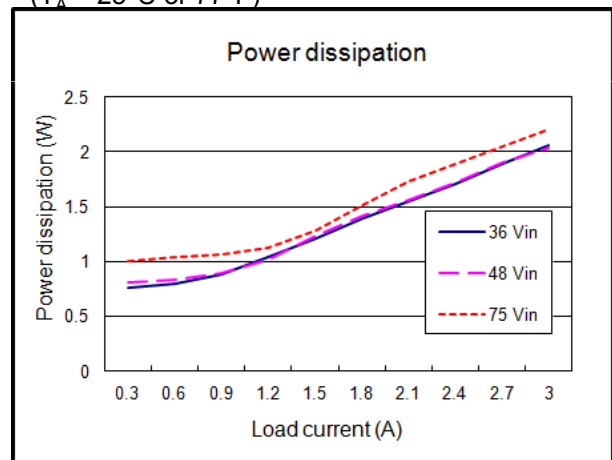

Figure 3: Thermal derating (Air is flowing from Vin to Vout; $V_{in} = 48\text{ V}$; $V_{out} = 5\text{ V}$)

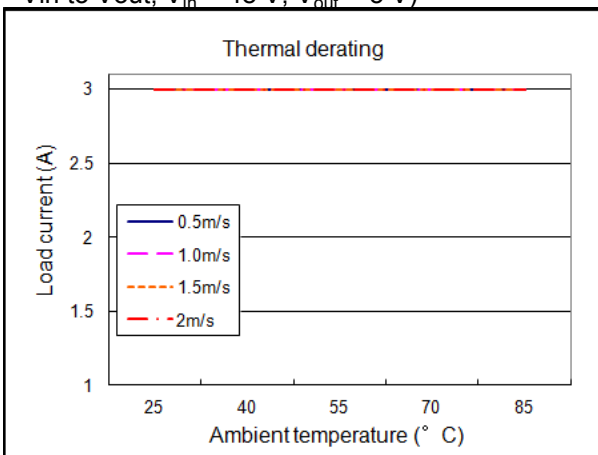

Figure 4: Thermal derating (Air is flowing from Vin(-) to Vin(+); $V_{in} = 48\text{ V}$; $V_{out} = 5\text{ V}$)

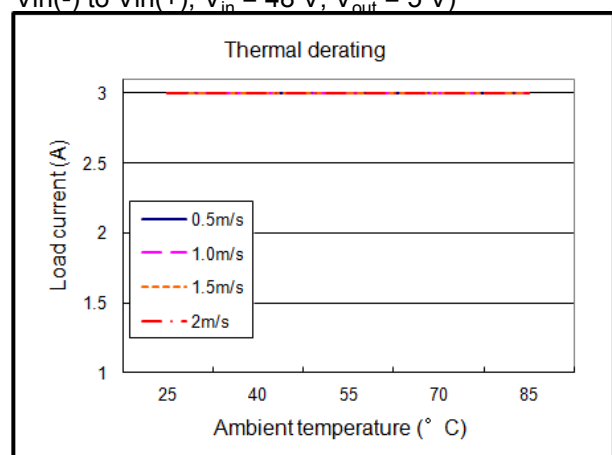

Figure 5: Thermal plot (Air is flowing from Vin to Vout; $T_A = 25^\circ\text{C}$ (77°F); Airflow = 1.5 m/s (300 FLM); Vin = 48 V; Vout = 5.0 V; Iout = 3 A)

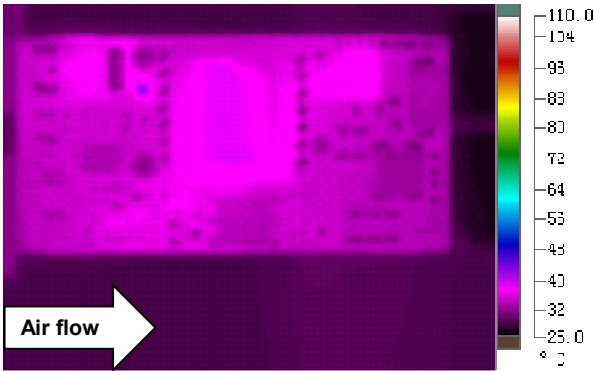
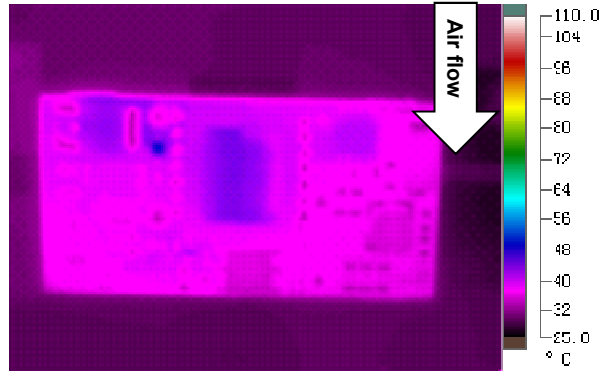

Figure 6: Thermal plot (Air is flowing from Vin(-) to Vin(+); $T_A = 25^\circ\text{C}$ (77°F); Airflow = 1.5 m/s (300 FLM); Vin = 48 V; Vout = 5.0 V; Iout = 3 A)



Typical Waveforms

Conditions: $T_A = 25^\circ\text{C}$ (77°F), Vin = 48 V.

Figure 7: Startup from CNT

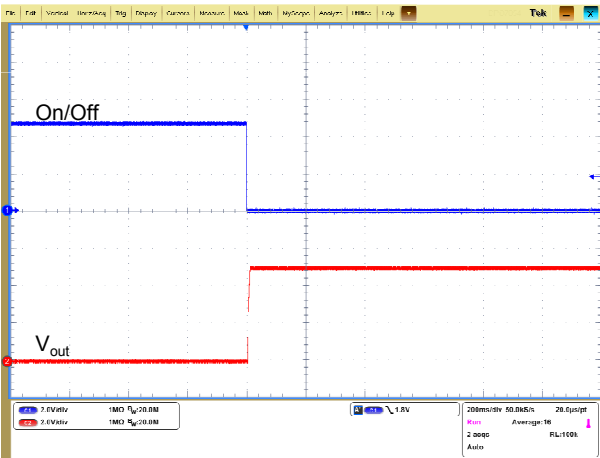

Figure 8: Shutdown from CNT

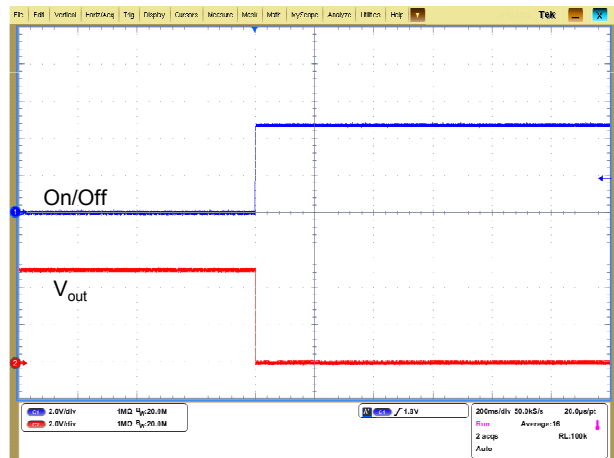

Figure 9: Startup from power on

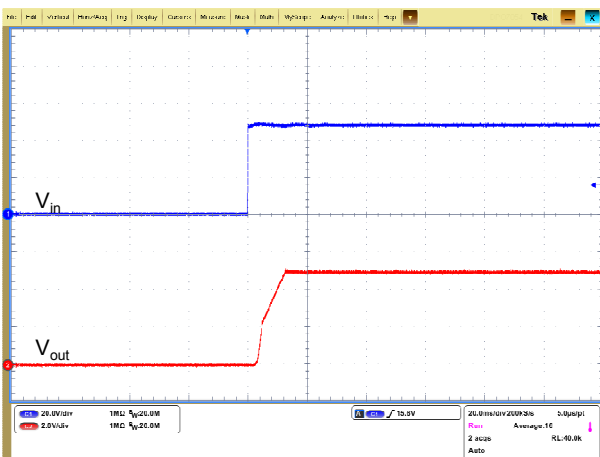

Figure 10: Shutdown from power off

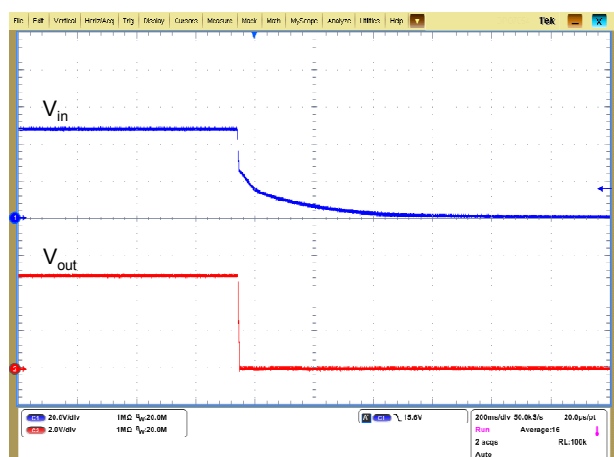

Figure 11: Output voltage response
(Load : 25%–50%–25%, $di/dt=0.1$ A/ μ s)

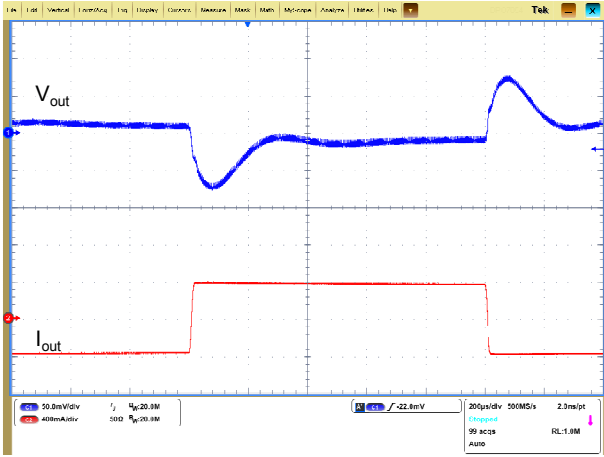

Figure 12: Output voltage response
(Load 50%–75%–50%, $di/dt=0.1$ A/ μ s)

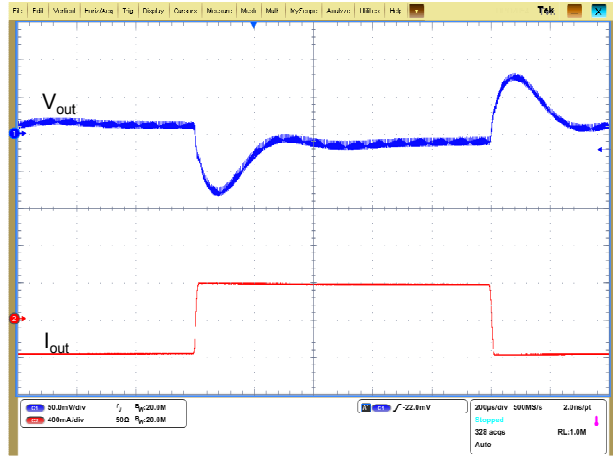
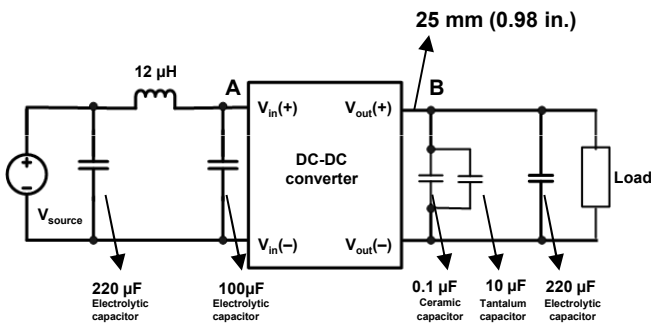

Figure 13: Test set-up diagram



NOTE

1. During the test of input reflected ripple current, the input terminal must be connected to a 12 μ H inductor and a 220 μ F electrolytic capacitor.
2. Point B, which is for testing the output voltage ripple, is 25 mm (0.98 in.) away from the $V_{out}(+)$ pin.

Conditions: $T_A = 25^\circ\text{C}$ (77°F), $V_{in} = 48$ V, $V_{out} = 5$ V, $I_{out} = 3$ A.

Figure 14: Input reflected ripple current
(for point A in the test set-up diagram)

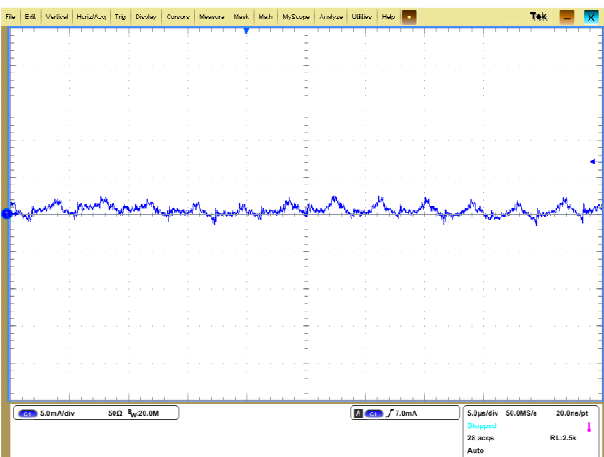
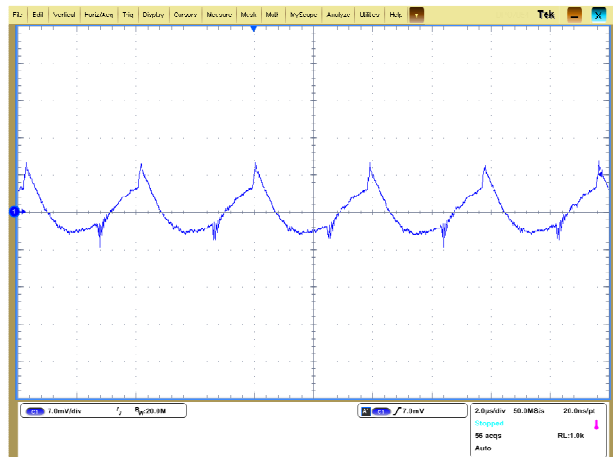

Figure 15: Output voltage ripple
(for point B in the test set-up diagram)



Feature Description

Remote On/Off

Logic Enable	On/Off Pin Level	Status
Negative logic	Low level	Started
	High level or left open	Shut down

The following are some circuits for driving the on/off pin.

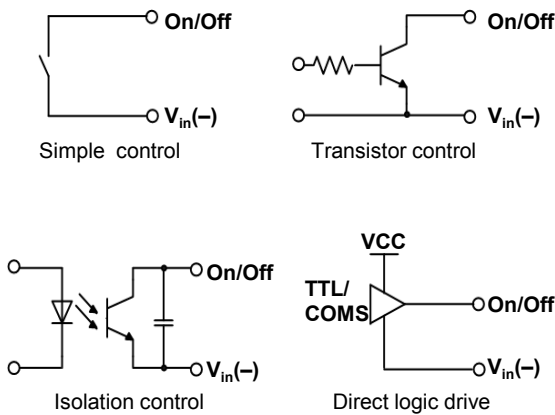

Output Voltage Trim

The output voltage can be adjusted within the range of 90% V_{nom} to 110% V_{nom} using a trim pin.

NOTE

If the trim pin is not used, it should be left open.

Trim Up

The output voltage can be increased by installing an external resistor between the trim pin and the $V_{out(-)}$ terminal.

Figure 15: Configuration diagram for raising the output voltage

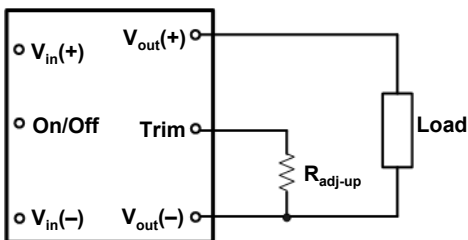

The following formula reflects the relationship between R_{adj-up} and V_{out} :

$$R_{adj-up} = \frac{1.88}{\Delta} - 10(kohm)$$

$$\text{Where, } \Delta = \frac{V_{out} - V_{nom}}{V_{nom}}$$

NOTE

Although the output voltage can be increased by both the remote sense and trim functions, the maximum increase in the output voltage is the larger value, rather than the sum of both values.

The GAC03S05 loading capability decreases as the voltage increases. Therefore, you need to ensure that the actual output power does not exceed the maximum output power when raising the voltage.

Trim Down

The output voltage can be decreased by installing an external resistor between the trim pin and the $V_{out(+)}$ terminal.

Figure 16: Configuration diagram for lowering the output voltage

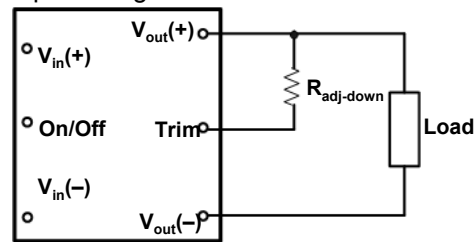

The following formula reflects the relationship between $R_{adj-down}$ and V_{out} :

$$R_{adj-down} = \frac{5.63}{\Delta} - 17.5(kohm)$$

$$\text{Where, } \Delta = \frac{V_{nom} - V_{out}}{V_{nom}}$$

Input Undervoltage Protection

The GAC03S05 is shut down after the input voltage drops below the undervoltage protection threshold for shutdown. The GAC03S05 starts to work again after the input voltage reaches the input undervoltage protection threshold for startup.

Output Overcurrent Protection

When the output current exceeds the overcurrent protection threshold, the GAC03S05 works in hiccup mode until overcurrent disappears. After the output current drops to the specified range, the GAC03S05 starts to work in normal mode.

Output Overvoltage Protection

When the output voltage exceeds the overvoltage protection threshold, the GAC03S05 works in hiccup mode.

MTBF

The MTBF is calculated according to the Telcordia, SR332 Method 1 Case3. If the GAC03S05 is used at 40°C (104°F), the airflow over it can be increased to retain the MTBF.

Recommended Reverse Polarity Protection Circuit

Reverse polarity protection is recommended under installation and cabling conditions where reverse polarity across the input may occur.

Figure 17: Recommended reverse polarity protection circuits

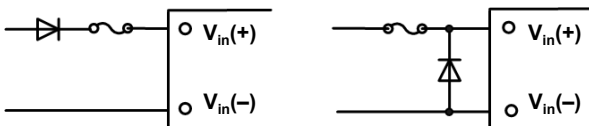

Recommended Fuse

The GAC03S05 has no internal fuse, but connects to an external fuse in actual use. To meet safety and regulatory requirements, a 1 A fuse is recommended.

NOTE

The fuse current should be 1.5 to 2 times the maximum operating current in actual use.

EMC

For the acceptance standard, see the *DC-DC Converter EMC Acceptance Manual*.

Figure 18: EMC test set-up diagram

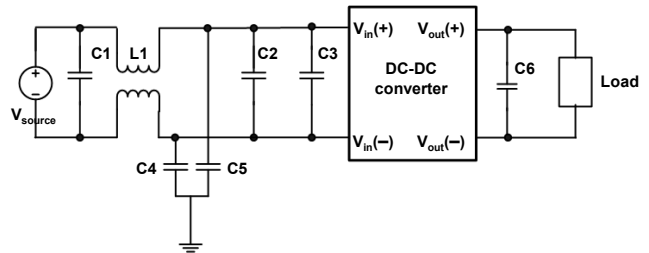

C1: Surface mount device (SMD) ceramic capacitor (100 V/1000 nF/X7R/1210)

C2: SMD ceramic capacitor (100 V/100 nF/±10%/X7R/1206)

L1: Common-mode inductor (single phase, 1320 μH/±25%/4 A/R5K/ 21 mm x 21 mm x 12.5 mm [0.83 in. x 0.83 in. x 0.49 in.]). The chip component with the same specifications can also be used.

C4: Plug-in film safety regulation capacitor (0.022 μF/250 V), meeting the 1 kV pressure resistance requirement.

C5: High-pressure resistant chip ceramic capacitor (22 nF/1000 V/X7R/1210). Chip ceramic capacitors are preferred.

C3: Electrolytic capacitor (100 μF/100 V)

C6: Electrolytic capacitor (220 μF)

Typical Application

Figure 19: Typical circuit applications

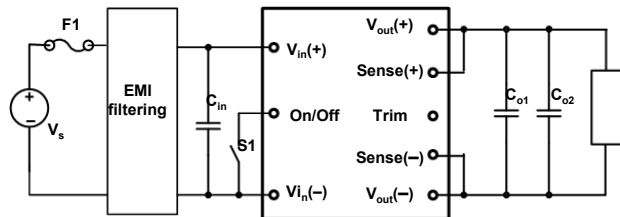

F1: 1 A fuse (fast blowing)

C_{in}: The high-frequency, low equivalent series resistance (ESR) electrolytic capacitor (100 μF/100 V) is recommended.

C₀₁: The 0.1 μF/50 V ceramic capacitor is recommended.

C₀₂: The 220 μF electrolytic capacitor is recommended.

NOTE

GAC03S05s cannot be connected in parallel.

Power Dissipation

The GAC03S05 power dissipation is calculated based on efficiency. The following formula reflects the relationship between the consumed power (P_d), efficiency (η), and output power (P_o):

$$P_d = P_o(1-\eta)/\eta$$

Mechanical Considerations

Installation

Although the GAC03S05 can be mounted in any direction, free airflow must be taken. Normally power components are always installed at the end of the airflow path or have separate airflow paths. The installation mode helps keep other system equipment cooler and increase component service life.

Soldering

The GAC03S05 is compatible with standard wave soldering techniques. During wave soldering, the setting parameters should base on the speciality of using flux, such as the preheating temperature and time, the soldering temperature and time and so on. To improve the soldering heighten, it is allowed to improve the preheating and soldering temperature, prolong the preheating and soldering time as the larger thermal capacity of the module. However, it is not allowed to exceed the high temperature limitation of the components that belong to the module.

When soldering the GAC03S05, ensure that the soldering iron is at 425°C (797°F) and contacts pins for a maximum of 3 seconds, because long-time soldering at high temperatures may cause the GAC03S05 interior to be damaged.

The GAC03S05 can be rinsed using the isopropyl alcohol (IPA) solvent or other proper solvents.