

# GAQ02S54B

## DC-DC Converter Technical Manual V1.4

Quarter-Brick  
DC-DC Converter

36 - 75 V  
Input

53.5 V Output

1.5 A Current

Negative  
Logic

### Description

The GAQ02S54B is a new generation isolated DC-DC converter that uses an industry standard quarter-brick structure, and features high efficiency and power density, operates from an input voltage range of 36 V to 75 V, provides the rated output voltage of 53.5 V and the maximum output current of 1.5 A.

### Operational Features

- Input voltage: 36 - 75 V
- Output current: 0 - 1.5 A
- Low output ripple and noise
- Efficiency: 92.5% (53.5 V, 1.5 A)

### Mechanical Features

- Industry standard quarter-brick (D x W x H, with a baseplate): 57.9 mm x 36.8 mm x 12.7 mm (2.28 in. x 1.45 in. x 0.50 in.)
- Weight: about 50 g

### Protection Features

- Input undervoltage protection
- Output overcurrent protection (hiccup mode)
- Output short circuit protection (hiccup mode)
- Output overvoltage protection (hiccup mode)
- Overtemperature protection (self-recovery)

### Control Features

- Remote on/off
- Remote sense
- Output voltage trim

### Safety Features

- UL60950-1 and CSA C22.2 No. 60950-1-07
- Meet UL94V-0 flammability requirements
- RoHS6 compliant



**GAQ02S54B**

# GAQ02S54B

## DC-DC Converter Technical Manual V1.4

### Designation Explanation

GAQ 02 S 54 B  
1 2 3 4 5

- 1 — 48Vin, high performance, analog control quarter-brick
- 2 — Output current: 1.5 A
- 3 — Single output
- 4 — Output voltage: 53.5 V
- 5 — With a baseplate

### Mechanical Diagram

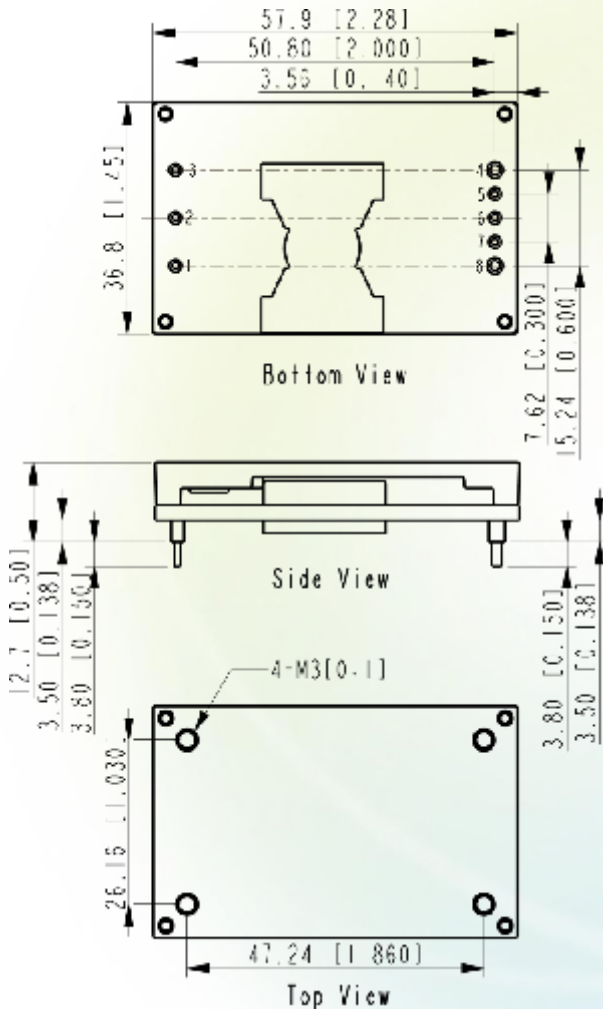

### Pin Description

Pin No.	Function
1	$V_{in} (+)$
2	On/Off
3	$V_{in} (-)$
4	$V_{out} (-)$
5	Sense (-)
6	Trim
7	Sense (+)
8	$V_{out} (+)$

### NOTE

1. All dimensions in mm [in.]  
Tolerances:  $x.x \pm 0.5$  mm [ $x.xx \pm 0.02$  in.]  
 $x.xx \pm 0.25$  mm [ $x.xxx \pm 0.010$  in.]
2. Pin 1-3, 5-7 are  $1.00 \pm 0.05$  mm [ $0.040 \pm 0.002$  in.] diameter with  $2.00 \pm 0.10$  mm [ $0.080 \pm 0.004$  in.] diameter standoff shoulders.  
Pin4 and pin8 are  $1.50 \pm 0.05$  mm [ $0.060 \pm 0.002$  in.] diameter with  $2.50 \pm 0.10$  mm [ $0.098 \pm 0.004$  in.] diameter standoff shoulders.
3. M3 Screw used to bolt unit's baseplate to other surfaces (such as heatsink) must not exceed 3.00 mm (0.120 in.) depth below the surface of baseplate.

# GAQ02S54B

## DC-DC Converter Technical Manual V1.4

### Electrical Specifications

Conditions:  $T_A = 25^\circ\text{C}$  (77°F), Airflow = 1 m/s (200 LFM),  $V_{in} = 48\text{ V}$ , unless otherwise notes.

Parameter	Min.	Typ.	Max.	Units	Notes & Conditions
<b>Absolute maximum ratings</b>					
Input voltage					
Continuous	-	-	80	V	-
Transient (100 ms)	-	-	100	V	-
Operating ambient temperature	-40	-	85	°C	See the thermal derating curve
Storage temperature	-55	-	125	°C	-
Operating humidity	-	-	95	% RH	Non-condensing
<b>Input characteristics</b>					
Operating input voltage	36	48	75	V	-
Maximum input current	-	-	3.5	A	$V_{in} = 36\text{ V}$ ; $I_{out} = 1.5\text{ A}$
No-load loss	-	1.25	-	W	$V_{in} = 48\text{ V}$ ; $I_{out} = 0\text{ A}$
Input capacitance	47	100	-	μF	Aluminum electrolytic capacitor
Inrush transient	-	-	1	A <sup>2</sup> s	-
Input reflected ripple current (peak to peak)	-	20	30	mA	Oscilloscope bandwidth: 20 MHz
<b>Output characteristics</b>					
Output voltage set point	52.7	53.5	54.3	V	$V_{in} = 36 - 75\text{ V}$ ; $I_{out} = 1.5\text{ A}$
Output power	0	-	80	W	-
Output line regulation	-	-	±0.5	%	$V_{in} = 36 - 75\text{ V}$ ; $I_{out} = 1.5\text{ A}$
Output load regulation	-	-	±1.5	%	$V_{in} = 48\text{ V}$ ; $I_{out} = 0 - 1.5\text{ A}$
Regulated voltage precision	-	-	±1.5	%	$V_{in} = 36 - 75\text{ V}$ ; $I_{out} = 0 - 1.5\text{ A}$
Temperature coefficient	-	-	0.02	% $V_{out}$ / °C	$T_A = -40^\circ\text{C}$ to $+85^\circ\text{C}$ ( $-40^\circ\text{F}$ to $+185^\circ\text{F}$ )
External capacitance	100	220	1000	μF	Aluminum electrolytic capacitor
Output current	0	-	1.5	A	-
Output ripple and noise (peak to peak)	-	100	200	mV	Oscilloscope bandwidth: 20 MHz
Output voltage Trim range	36	53.5	57	V	-
Output voltage overshoot	-	-	5	%	The whole range of $V_{in}$ , $I_{out}$ and $T_A$
Output voltage delay time	-	200	500	ms	The whole range of $V_{in}$ , $I_{out}$ and $T_A$
Output voltage rise time	-	200	500	ms	The whole range of $V_{in}$ , $I_{out}$ and $T_A$
Switching frequency	-	200	-	kHz	-

# GAQ02S54B

## DC-DC Converter Technical Manual V1.4

### Electrical Specifications

Conditions:  $T_A = 25^\circ\text{C}$  (77°F), Airflow = 1 m/s (200 LFM),  $V_{in} = 48\text{ V}$ , unless otherwise notes.

Parameter	Min.	Typ.	Max.	Units	Notes & Conditions
<b>Protection characteristics</b>					
Input undervoltage protection					
Startup threshold	31	34	36	V	-
Shutdown threshold	30	33	35	V	-
Hysteresis	1	-	3	V	-
Output overcurrent protection	1.65	2.20	2.80	A	Hiccup mode
Output overvoltage protection	59	63	66	V	Hiccup mode
Overtemperature protection					Self-recovery
Threshold	100	-	125	$^\circ\text{C}$	The values are obtained by measuring the temperature of the hottest power component on the top surface of the converter
Hysteresis	5	-	-	$^\circ\text{C}$	
<b>Dynamic characteristics</b>					
Overshoot amplitude	-	-	2500	mV	Current change rate: 0.1 A/ $\mu\text{s}$
Recovery time	-	-	500	$\mu\text{s}$	load : 25% - 50% - 25%
Overshoot amplitude	-	-	3000	mV	Current change rate: 0.1 A/ $\mu\text{s}$
Recovery time	-	-	500	$\mu\text{s}$	load : 50% - 75% - 50%
<b>Efficiency</b>					
100% load	90.0	92.5	-	%	$V_{in} = 48\text{ V}$ ; $I_{out} = 1.5\text{ A}$ ; $T_A = 25^\circ\text{C}$ (77°F)
50% load	85.0	91.0	-	%	$V_{in} = 48\text{ V}$ ; $I_{out} = 0.75\text{ A}$ ; $T_A = 25^\circ\text{C}$ (77°F)
20% load	-	86.5	-	%	$V_{in} = 48\text{ V}$ ; $I_{out} = 0.3\text{ A}$ ; $T_A = 25^\circ\text{C}$ (77°F)
<b>Isolation characteristics</b>					
Input-to-output Isolation voltage	-	-	1500	V DC	Functional Isolation
<b>Other characteristics</b>					
Remote on/off voltage					
Low level	-0.7	-	1.2	V	-
High level	3.5	-	12	V	-
On/Off current					
Low level	-	-	1.0	mA	-
High level	-	-	-	$\mu\text{A}$	-
<b>Reliability characteristics</b>					
Mean time between failures (MTBF)	-	1.5	-	Million hours	Telcordia SR332; 80% load; Airflow = 1.5m/s (300 LFM); $T_A = 40^\circ\text{C}$ (104°F)

### Characteristic Curves

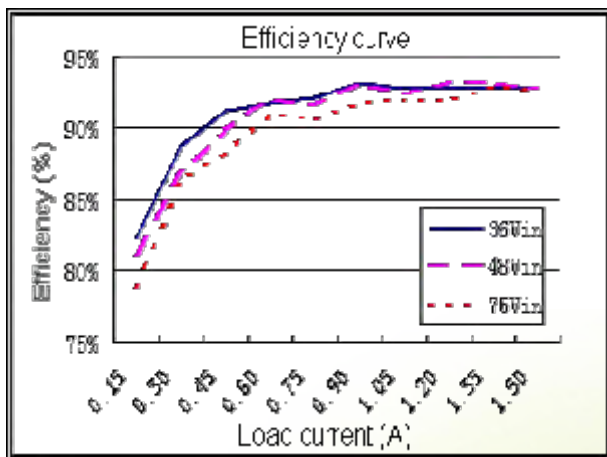

Figure 1: Efficiency ( $T_A = 25^\circ\text{C}$  or  $77^\circ\text{F}$ )

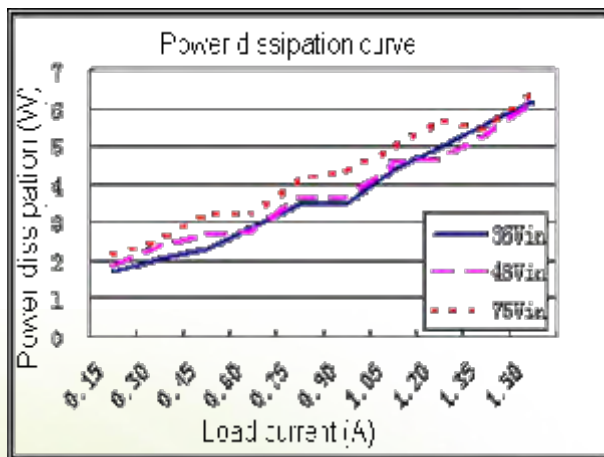

Figure 2: Power dissipation ( $T_A = 25^\circ\text{C}$  or  $77^\circ\text{F}$ )

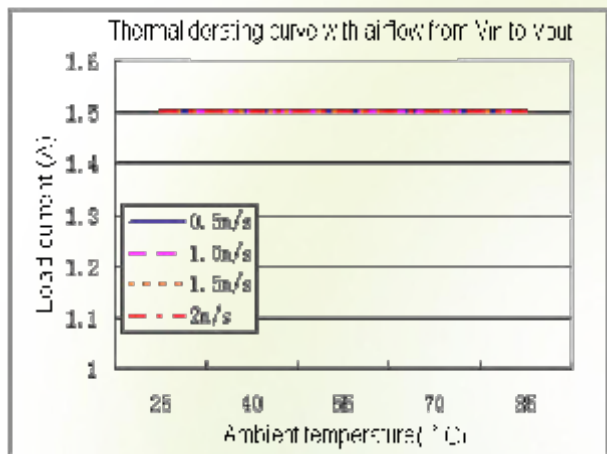

Figure 3: Thermal derating with airflow from  $V_{in(-)}$  to  $V_{out}$  ( $V_{in} = 48\text{ V}$ ;  $V_{out} = 53.5\text{ V}$ )

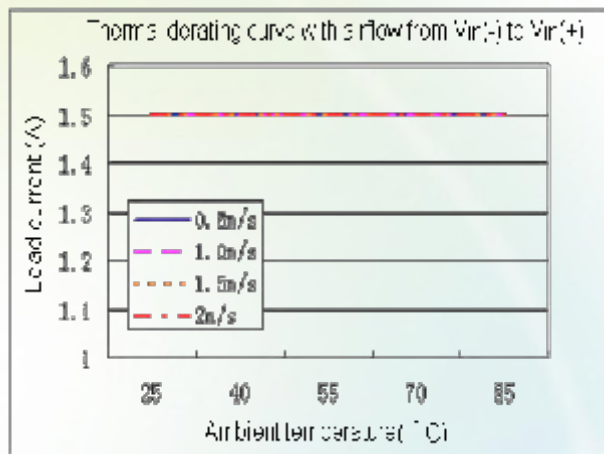

Figure 4: Thermal derating with airflow from  $V_{in(-)}$  to  $V_{in(+)}$  ( $V_{in} = 48\text{ V}$ ;  $V_{out} = 53.5\text{ V}$ )



# GAQ02S54B

## DC-DC Converter Technical Manual V1.4

### Typical Waveforms



#### NOTE

1. During the test of input reflected ripple current, the input terminal must be connected to a 12  $\mu\text{H}$  inductor and a 220  $\mu\text{F}$  electrolytic capacitor.
2. Point B, which is for testing the output voltage ripple, is 25 mm (0.98 in.) away from the  $V_{\text{out}(+)}$  pin.

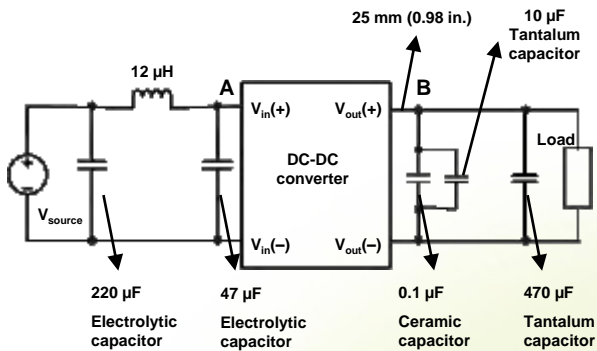

Figure 5: Test set-up diagram

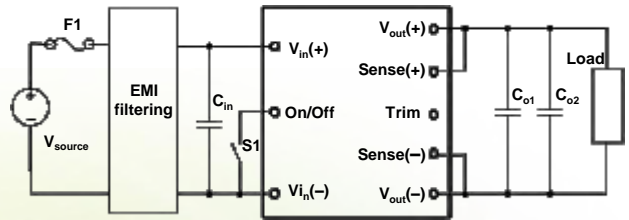

Figure 6: Typical circuit applications

F1: 7 A fuse (fast blowing)

$C_{\text{in}}$ : The high-frequency, low equivalent series resistance (ESR) electrolytic capacitor (100  $\mu\text{F}/100\text{ V}$ ) is recommended.

$C_{\text{o1}}$ : The 1  $\mu\text{F}$  ceramic capacitor is recommended.

$C_{\text{o2}}$ : The 470  $\mu\text{F}$  tantalum capacitor is recommended.

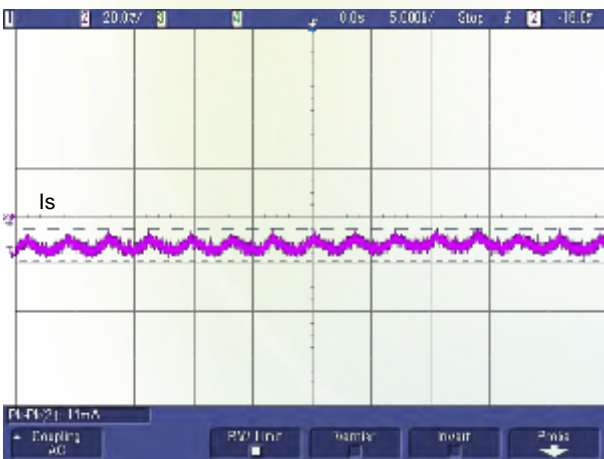

Figure 7: Input reflected ripple current (for point A in the test set-up diagram,  $V_{\text{in}} = 48\text{ V}$ ,  $V_{\text{out}} = 53.5\text{ V}$ ,  $I_{\text{out}} = 1.5\text{ A}$ )

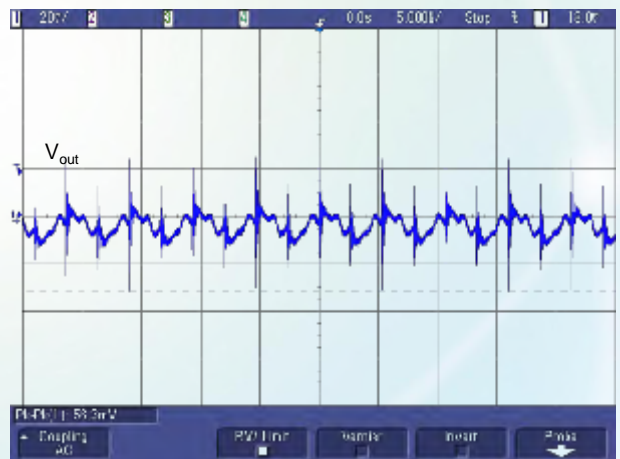

Figure 8: Output voltage ripple (for point B in the test set-up diagram,  $V_{\text{in}} = 48\text{ V}$ ,  $V_{\text{out}} = 53.5\text{ V}$ ,  $I_{\text{out}} = 1.5\text{ A}$ )

### Typical Waveforms

Conditions:  $T_A = 25^\circ\text{C}$  (77°F),  $V_{in} = 48\text{ V}$ .

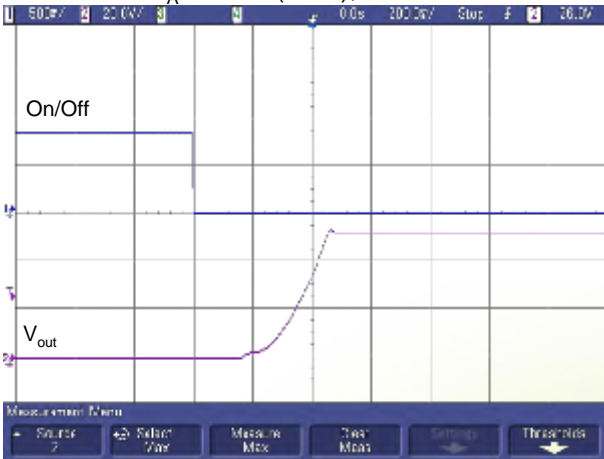

Figure 9: Startup from On/Off

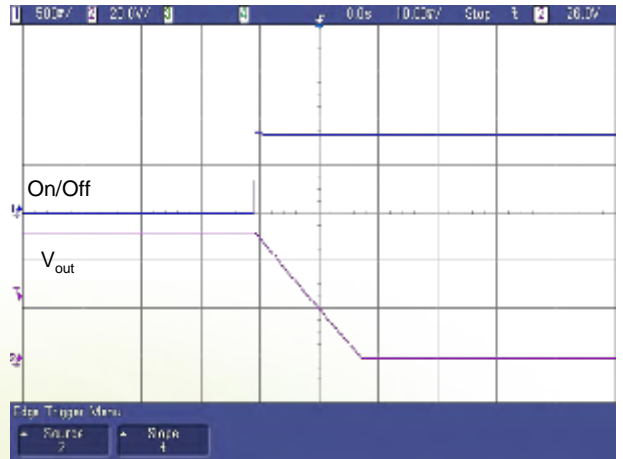

Figure 10: Shutdown from On/Off

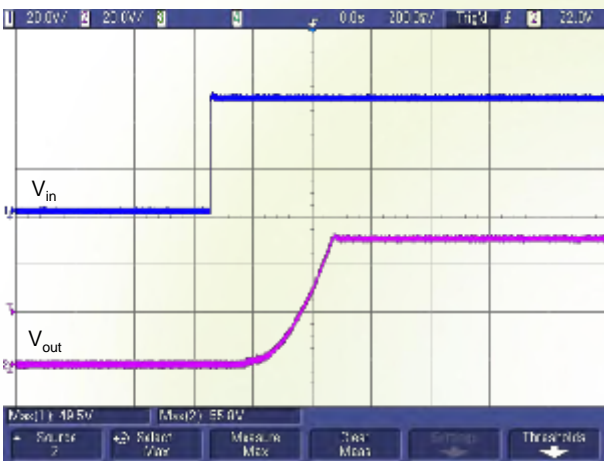

Figure 11: Startup by power on

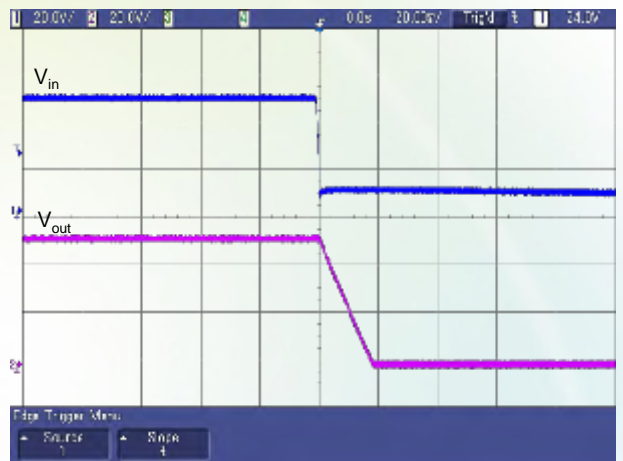

Figure 12: Shutdown by power off

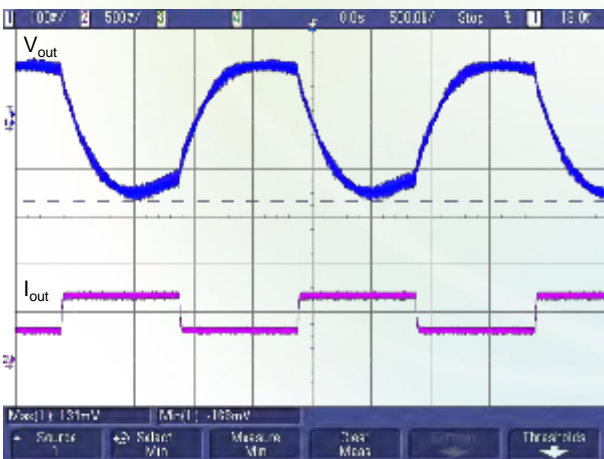

Figure 13: Output voltage dynamic response  
(Load: 25% - 50% - 25%,  $di/dt=0.1\text{ A}/\mu\text{s}$ )

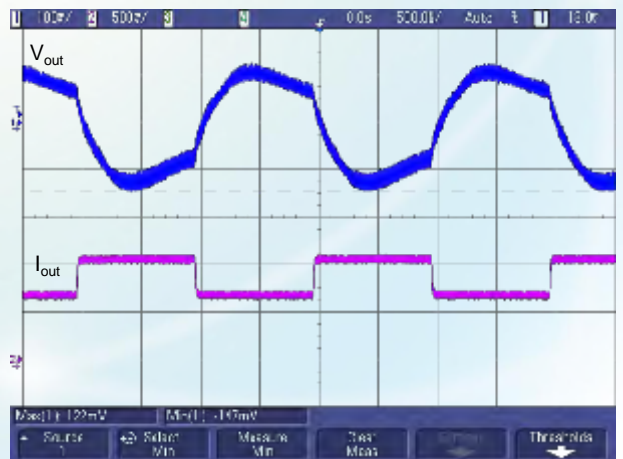

Figure 14: Output voltage dynamic response  
(Load: 50% - 75% - 50%,  $di/dt=0.1\text{ A}/\mu\text{s}$ )

### Remote On/Off

Logic Enable	On/Off Pin Level	Status
Negative logic	Low level	On
	High level or left open	Off

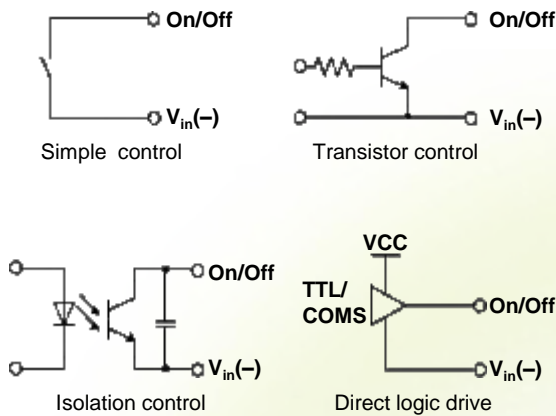

Figure 15: various circuits for driving the On/Off pin

### Remote Sense

This function is used to compensate for voltage drops on  $R_w$ . The Sense(+), Sense(-),  $V_{out}(+)$ , and  $V_{out}(-)$  terminals should meet the following requirements:

$$|V_{out}(+) - V_{out}(-) - [Sense(+) - Sense(-)]| \leq 10\% \times V_{nom}$$

( $V_{nom}$  is the rated output voltage.)

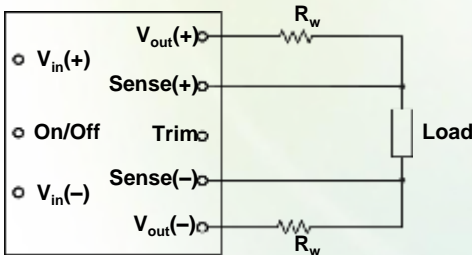

Figure 16: Configuration diagram for remote sense

$R_w$  indicates the line impedance between the output terminal and the load.

If the remote sense function is disabled, the Sense(+) terminal directly connects to the  $V_{out}(+)$  terminal and the Sense(-) terminal directly connects to the  $V_{out}(-)$  terminal.

### Output Voltage Trim

The output voltage can be adjusted according to the trim range specification by using the Trim pin.

#### Trim Up

The output voltage can be increased by installing an external resistor between the Trim pin and the Sense(-) pin.

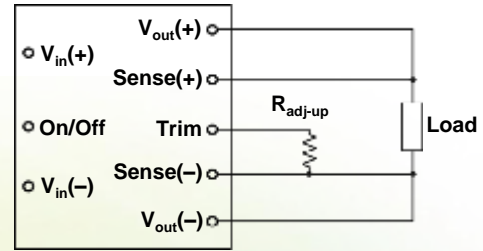

Figure 17: Configuration diagram for Trim up

The relationship between  $R_{adj-up}$  and  $V_{out}$ :

$$R_{adj-up} = \frac{127.5}{\Delta U} - 4.7(\text{kohm})$$

$$\Delta = |V_{adj-up} - V_{out}|$$

#### NOTE

1. If the Trim pin is not used, it should be left open.
2. Ensure that the actual output power does not exceed the maximum output power when raising the voltage.

#### Trim Down

The output voltage can be decreased by installing an external resistor between the Trim pin and the Sense(+) pin.

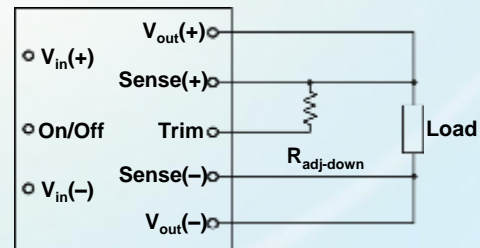

Figure 18: Configuration diagram for Trim down

The relationship between  $R_{adj-down}$  and  $V_{out}$ :

$$R_{adj-down} = \frac{51 \times 51}{\Delta U} - 55.7(\text{kohm}) \quad \Delta = |V_{adj-down} - V_{out}|$$



# GAQ02S54B

## DC-DC Converter Technical Manual V1.4

### Input Undervoltage Protection

The converter will shut down after the input voltage drops below the undervoltage protection threshold for shutdown. The converter will start to work again after the input voltage reaches the input undervoltage protection threshold for startup. For the Hysteresis, see the Protection characteristics.

### Output Overcurrent Protection

The converter equipped with current limiting circuitry can provide protection from an output overload or short circuit condition. If the output current exceeds the output overcurrent protection set point, the converter enters hiccup mode. When the fault condition is removed, the converter will automatically restart.

### Output Overvoltage Protection

When the voltage directly across the output pins exceeds the output overvoltage protection threshold, the converter will enter hiccup mode. When the fault condition is removed, the converter will automatically restart.

### Overtemperature Protection

A temperature sensor on the converter senses the average temperature of the module. It protects the converter from being damaged at high temperatures. When the temperature exceeds the overtemperature protection threshold, the output will shut down. It will allow the converter to turn on again when the temperature of the sensed location falls by the value of Overtemperature Protection Hysteresis.

### MTBF

The MTBF is calculated according to the Telcordia, SR332 Method 1 Case3.

### Recommend Reverse Polarity Protection Circuit

Reverse polarity protection is recommended under installation and cabling conditions where reverse polarity across the input may occur.

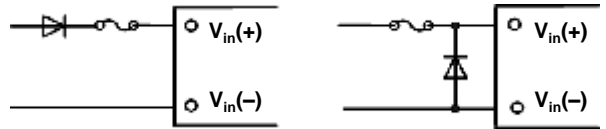

Figure 19: Recommend reverse polarity protection circuits

### Recommended Fuse

The converter has no internal fuse. To meet safety and regulatory requirements, a 7 A fuse is recommended.



#### NOTE

The fuse current should be 1.5 to 2 times the maximum operating current in actual use.

### EMC

For the acceptance standard, see the *DC-DC Converter EMC Acceptance Manual*.

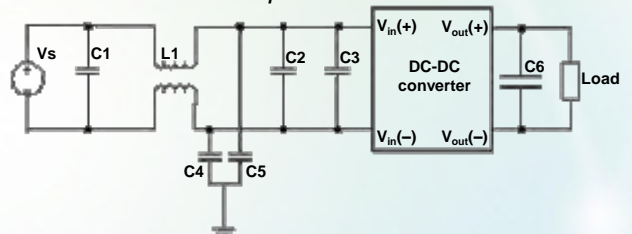

Figure 20: EMC test set-up diagram

C1: Surface mount device (SMD) ceramic capacitor (100 V/1000 nF/X7R/1210)

C2: SMD ceramic capacitor (100 V/100 nF/±10%/X7R/1206)

L1: Common-mode inductor (single phase, 1320 μH/±25%/4 A/R5K/ 21 mm x 21 mm x 12.5 mm [0.83 in. x 0.83 in. x 0.49 in.]). The chip component with the same specifications can also be used.

C4, C5: High-pressure resistant chip ceramic capacitor (22 nF/1000 V/X7R/1210)

C3: Electrolytic capacitor (100 μF/100 V)

C6: Electrolytic capacitor (470 μF/100 V)

# GAQ02S54B

## DC-DC Converter Technical Manual V1.4

### Qualification Testing

Parameter	Units	Condition
High Accelerated Life Test (HALT)	4	Lowest operating temperature: -60°C (-76°F); highest operating temperature: 110°C (230°F); vibration limit: 40 G
Proof Of Screen (POS)	4	80 temperature cycles; 50% vibration limit stress: 20 G
High Accelerated Stress Audit (HASA)	8	4 temperature cycles; 50% vibration limit stress: 20 G
Thermal Shock	32	500 temperature cycles between -40°C (-40°F) and +125°C (+257°F) with the temperature change rate of 20°C (68°F) per minute Lasting for 30 minutes both at -40°C (-40°F) and +125°C (+257°F)
Temperature Humidity Bias	16	85°C (185°F); 85% RH; 1000 operating hours under lowest load power
High Temperature Operation Life (HTOL)	16	Rated input voltage; 55°C (131°F); 1000 operating hours under 80% load power

### Thermal Consideration

#### Thermal Test Point

Sufficient airflow should be provided to ensure reliable operating of the converter. Therefore, thermal components are mounted on the top surface of the converter to dissipate heat to the surrounding environment by conduction, convection and radiation. Proper airflow can be verified by measuring the temperature at the thermal test point.

Middle of the baseplate



Figure 21: Thermal test point



#### NOTE

The temperature at the thermal test point on the converter cannot exceed 105°C (221°F). Otherwise, the converter will be protected against overtemperature and will not operate properly.

#### Power Dissipation

The converter power dissipation is calculated based on efficiency. The following formula reflects the relationship between the consumed power ( $P_d$ ), efficiency ( $\eta$ ), and output power ( $P_o$ ):  $P_d = P_o(1-\eta)/\eta$

# GAQ02S54B

## DC-DC Converter Technical Manual V1.4

### Mechanical Consideration

---

#### Installation

Although the converter can be mounted in any direction, free airflow must be taken.

#### Soldering

The converter is compatible with standard wave soldering techniques. When wave soldering, the converter pins should be preheated for 20 - 30 seconds at 110°C (230°F) , and wave soldered at 260°C (500°F) for less than 10 seconds.

When hand soldering, the iron temperature should be maintained at 425°C (797°F) and applied to the converter pins for less than 5 seconds.

The converter can be rinsed using the isopropyl alcohol (IPA) solvent or other proper solvents.

**HUAWEI TECHNOLOGIES CO., LTD.**  
Huawei Industrial Base Bantian Longgang  
Shenzhen 518129  
People's Republic of China  
[www.huawei.com](http://www.huawei.com)