

# GAQ25S12B

## DC-DC Converter Technical Manual V1.0

Date: 2012-02-25



<b>Quarter-Brick DC-DC Converter</b>	<b>36–75 V Input</b>	<b>12 V Output</b>	<b>25 A Current</b>	<b>Negative Logic</b>
--	--------------------------	------------------------	-------------------------	---------------------------

### Description

The GAQ25S12B is an isolated DC-DC converter that uses an industry-standard quarter-brick structure, and features high efficiency and power density. It has the dimensions of 12.7 mm x 57.9 mm x 36.8mm (0.50 in. x 2.28 in. x 1.45 in.) and provides the rated output voltage of 12 V and the maximum output current of 25 A.



**GAQ25S12B**

### Operational Features

- Input voltage: 36–75 V
- Output current: 0–25A
- Low output ripple and noise
- Efficiency: 95.7% (12 V, 12.5 A)

### Mechanical Features

- Industry standard quarter brick (H x W x D, without a base plate): 12.7 mm x 57.9 mm x 36.8mm (0.50 in. x 2.28 in. x 1.45 in.)
- Weight: about 70 g

### Protection Features

- Input undervoltage protection
- Output overcurrent protection (hiccup mode)
- Output short circuit protection (hiccup mode)
- Output overvoltage protection (hiccup mode)
- Overtemperature protection (self-recovery)

### Control Features

- Remote on/off
- Remote sense
- Output voltage trim

### Safety Features

- UL60950-1
- Underwriters Laboratory (UL) certification
- Class B requirements in EN55022 (after connecting to an external filtering circuit)
- UL94V-0
- Restriction of the use of certain hazardous substance (RoHS) 6

## Mechanical Diagram

Unit of measurement: mm (in.)

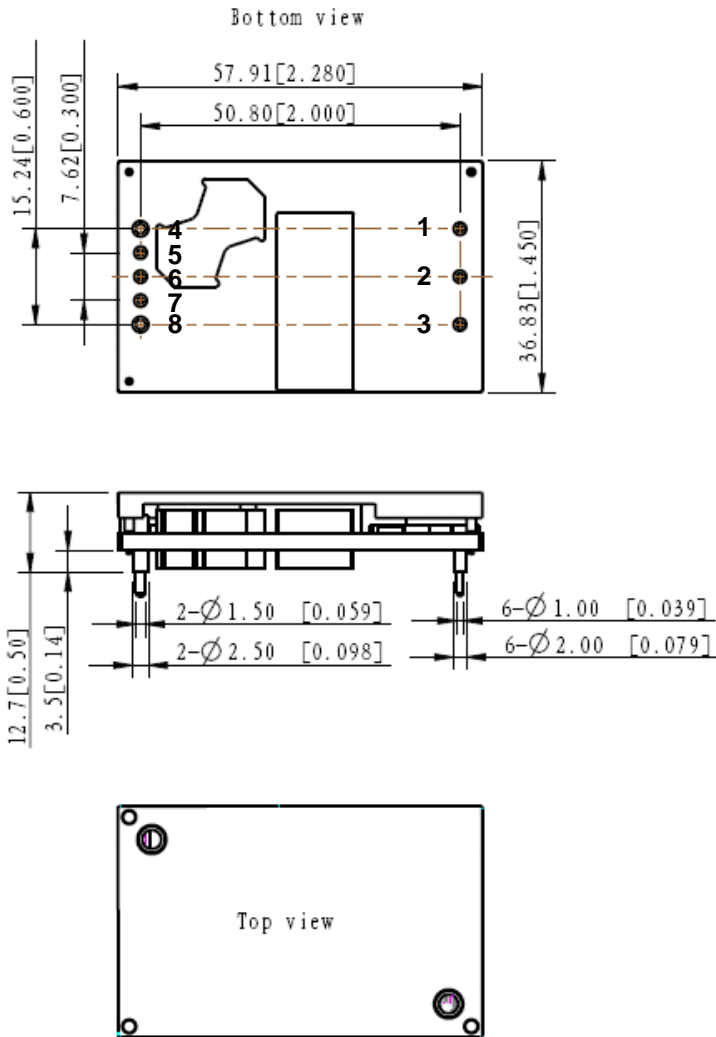

### Pin description

Pin No.	Function
1	$V_{in} (+)$
2	CNT
3	$V_{in} (-)$
4	$V_{out} (+)$
5	Sense (+)
6	Trim
7	Sense (-)
8	$V_{out} (-)$

### Dimensions tolerance

.x	$\pm 0.2$ mm (0.008 in.)
.xx	$\pm 0.13$ mm (0.005 in.)

## Designation Explanation

G A Q 25 S 12 B  
 1 2 3 4 5 6 7

- 1 — Isolated
- 2 — Analog
- 3 — Quarter-brick
- 4 — Output current: 25 A
- 5 — Single output
- 6 — Output voltage: 12 V
- 7 — with base plate

## Electrical Specifications

Conditions:  $T_A = 25^\circ\text{C}$  (77°F), Airflow = 1.0 m/s (200 LFM),  $V_{in} = 48\text{ V}$ ,  $V_{out} = 12\text{ V}$ , unless otherwise specified.

Parameter	Min.	Typ.	Max.	Units	Remarks
<b>Absolute maximum ratings</b>					
Input voltage					
Continuous	-	-	80	V	-
Transient (100 ms)	-	-	100	V	-
Operating ambient temperature	-40	-	85	°C	See the thermal derating curve.
Storage temperature	-55	-	125	°C	-
Operating humidity	10	-	95	% RH	Non-condensing
<b>Input characteristics</b>					
Operating input voltage	36	48	75	V	-
Maximum input current	-	-	10	A	$V_{in} = 0 - V_{inmax}$ ; $I_{out} = I_{omax}$
No-load loss	-	3.5	-	W	$V_{in} = 48\text{ V}$
Input capacitance	220	-	-	μF	Electrolytic capacitor
Inrush transient	-	-	1	A <sup>2</sup> s	-
Input reflected ripple current	-	20	100	mAp-p	Oscilloscope bandwidth: 20 MHz
<b>Output characteristics</b>					
Output voltage setpoint	11.7	-	12.3	V	$I_{out} = 12.5\text{ A}$
Output power	-	-	300	W	-
Output line regulation	-	-	0.2	%Vo	$V_{in} = 36-75\text{ V}$ ; $I_{out} = 25\text{ A}$
Output load regulation	-	-	3	%Vo	$V_{in} = 48\text{ V}$ ; $I_{out} = 0-25\text{ A}$
Regulated voltage precision	-	-	3.5	%Vo	The whole range of $V_{in}$ and $I_{out}$
Temperature coefficient	-	-	0.02	%Vo/°C	$T_A = -40^\circ\text{C}$ to $+85^\circ\text{C}$ ( $-40^\circ\text{F}$ to $+185^\circ\text{F}$ )
External capacitance	220	-	10000	μF	Electrolytic capacitor
Output current	0	-	25	A	-
Output ripple and noise	-	35	150	mVp-p	Oscilloscope bandwidth: 20 MHz
Output voltage adjustment range(trim)	90	-	110	%Vo	-
Out voltage overshoot	-	-	5	%Vo	The whole range of $V_{in}$ , $I_{out}$ and $T_A$
Output voltage rise time	-	-	100	ms	The whole range of $V_{in}$ , $I_{out}$ and $T_A$
Switching frequency	-	280	-	kHz	-

## Electrical Specifications

Conditions:  $T_A = 25^\circ\text{C}$  (77°F), Airflow = 1.0 m/s (200 LFM),  $V_{in} = 48\text{ V}$ ,  $V_{out} = 12\text{ V}$ , unless otherwise specified.

Parameter	Min.	Typ.	Max.	Units	Remarks
<b>Protection Features</b>					
Input undervoltage protection					
Startup threshold	31	-	36	V	-
Shutdown threshold	30	-	35	V	-
Hysteresis	1	-	4	V	-
Output overcurrent protection	27	-	37	A	Hiccup mode
Output short circuit protection	-	-	-	-	Hiccup mode
Output overvoltage protection	13.8	-	16	V	Hiccup mode
Overtemperature protection					Self-recovery
Threshold	105	-	125	$^\circ\text{C}$	The values are obtained by measuring the temperature of the PCB bottom near the thermal resistor.
Hysteresis	-	10	-	$^\circ\text{C}$	
<b>Dynamic Characteristics</b>					
Overshoot amplitude	-	-	600	mV	Current change rate: 0.1 A/ $\mu\text{s}$ load : 25%–50%–25%; 50%–75%–50%
Recovery time	-	-	700	$\mu\text{s}$	
Overshoot amplitude	-	-	600	mV	Current change rate: 1 A/ $\mu\text{s}$ load : 25%–50%–25%; 50%–75%–50% Additional 1000 $\mu\text{F}$ load capacitor.
Recovery time	-	-	700	$\mu\text{s}$	
<b>Efficiency</b>					
100% load	-	95.1	-	%	$V_{in} = 48\text{ V}$ ; $I_{out} = 25\text{ A}$ ; $T_A = 25^\circ\text{C}$ (77°F)
50% load	-	95.7	-	%	$V_{in} = 48\text{ V}$ ; $I_{out} = 12.5\text{ A}$ ; $T_A = 25^\circ\text{C}$ (77°F)
20% load	-	93.0	-	%	$V_{in} = 48\text{ V}$ ; $I_{out} = 5\text{ A}$ ; $T_A = 25^\circ\text{C}$ (77°F)
<b>Isolation characteristics</b>					
Input-to-output Isolation voltage	-	1500	-	V DC	Basic Isolation
<b>Other features</b>					
Remote on/off voltage					
Low level	0	-	1.2	V	-
High level	3.5	-	12	V	-
On/Off current					
Low level	-	-	1.0	mA	-
High level	-	-	-	$\mu\text{A}$	-
<b>Reliability characteristics</b>					
Mean time between failures (MTBF)	-	1.5	-	Million hours	Airflow = 1.5 m/s (300 LFM); $T_A = 40^\circ\text{C}$ (104°F); 80% load; Telcordia SR332 Method 1 case 3

## Qualification Testing

Parameter	Units	Condition
High Accelerated Life Test (HALT)	4	Lower operating limit: $-60^{\circ}\text{C}$ ( $-76^{\circ}\text{F}$ ); upper operating limit: $120^{\circ}\text{C}$ ( $248^{\circ}\text{F}$ ); destruct limit: $40^{\circ}\text{C}$
Thermal Shock	32	500 temperature cycles between $-40^{\circ}\text{C}$ ( $-40^{\circ}\text{F}$ ) and $+125^{\circ}\text{C}$ ( $+257^{\circ}\text{F}$ ) with the temperature change rate of $20^{\circ}\text{C}$ ( $68^{\circ}\text{F}$ ) per minute Lasting for 30 minutes both at $-40^{\circ}\text{C}$ ( $-40^{\circ}\text{F}$ ) and $+125^{\circ}\text{C}$ ( $+257^{\circ}\text{F}$ )
Temperature Humidity Bias	16	$85^{\circ}\text{C}$ ( $185^{\circ}\text{F}$ ); 85% RH; no load; operating 1000 hours
High Temperature Operation Life (HTOL)	16	Rated input voltage; airflow: 2.0 m/s (400 LFM); ambient temperature: $65^{\circ}\text{C}$ ( $149^{\circ}\text{F}$ ); operating 1000 hours under 50%–80% load

## Characteristic Curves

Figure 1: Efficiency  
( $T_A = 25^{\circ}\text{C}$  or  $77^{\circ}\text{F}$ )

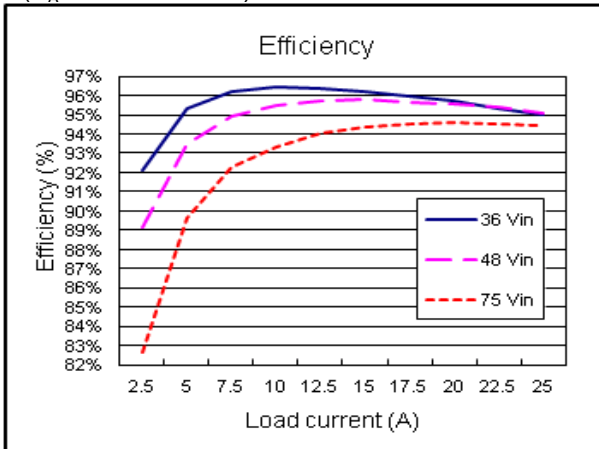

Figure 2: Power dissipation  
( $T_A = 25^{\circ}\text{C}$  or  $77^{\circ}\text{F}$ )

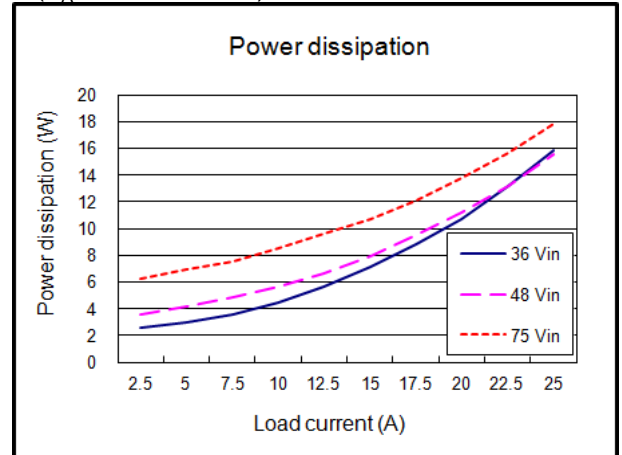

Figure 3: Thermal derating (Air is flowing from Vin to Vout;  $V_{in} = 48\text{ V}$ ;  $V_{out} = 12\text{ V}$ )

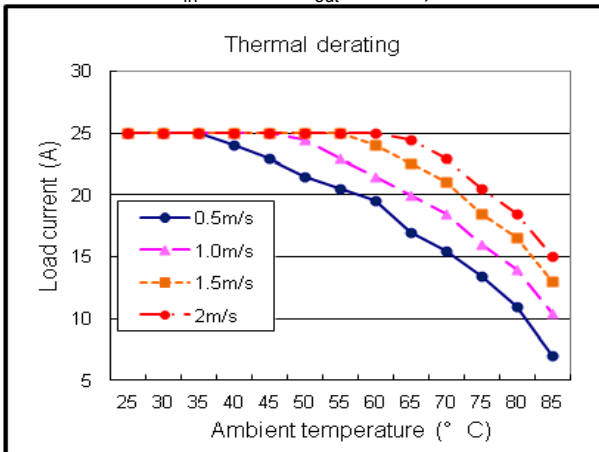
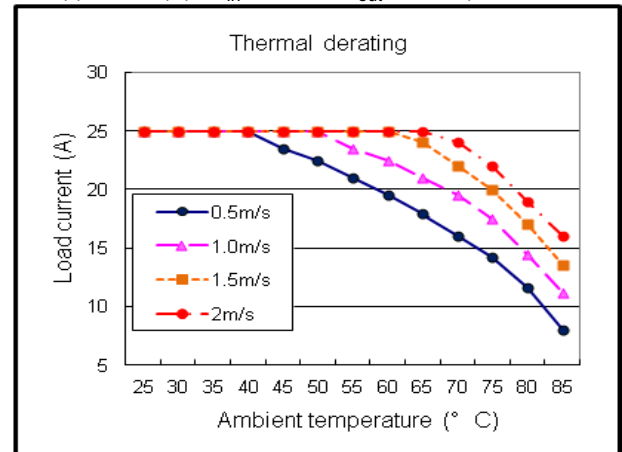

Figure 4: Thermal derating (Air is flowing from Vin(-) to Vin(+);  $V_{in} = 48\text{ V}$ ;  $V_{out} = 12\text{ V}$ )



## Typical Waveforms

Conditions:  $T_A = 25^\circ\text{C}$  (77°F),  $V_{in} = 48\text{ V}$ .

Figure 5: Startup from CNT

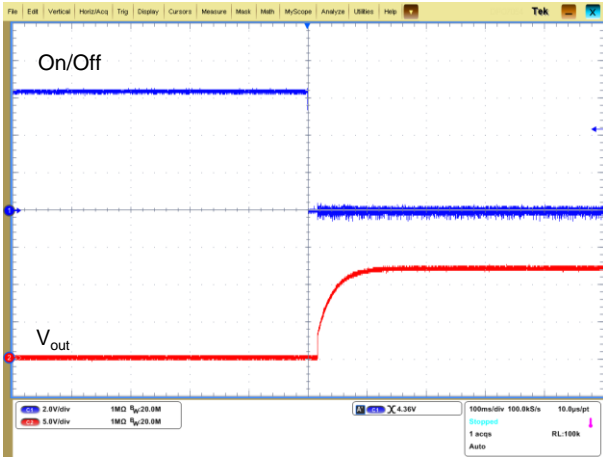

Figure 7: Startup from power on

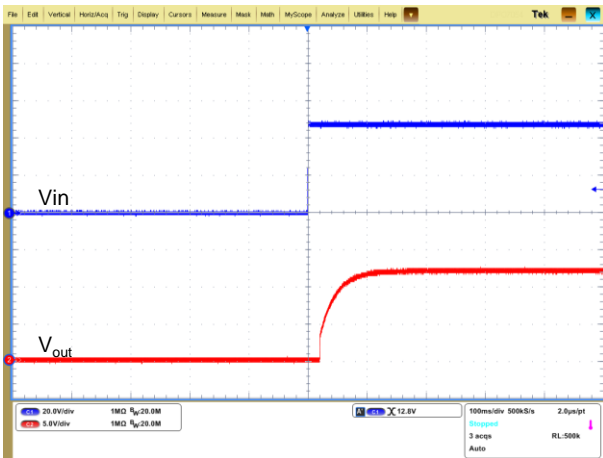

Figure 9: Output voltage response  
 (Load : 25%–50%–25%,  $dI/dt=0.1\text{ A}/\mu\text{s}$ )

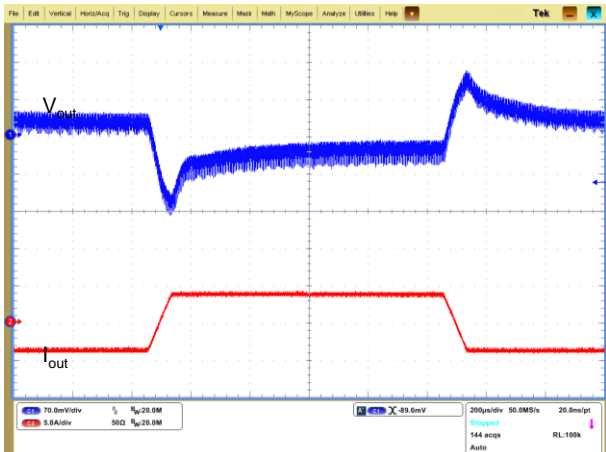

Figure 6: Shutdown from CNT

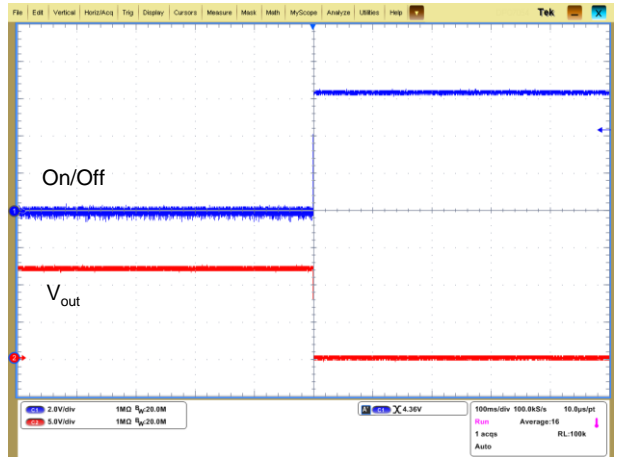

Figure 8: Shutdown from power off

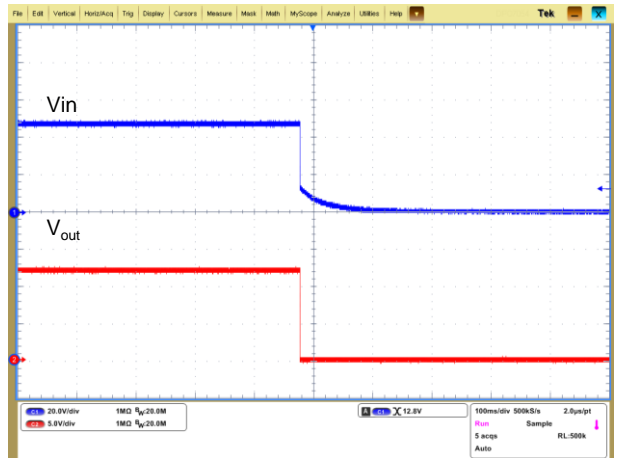

Figure 10: Output voltage response  
 (Load 50%–75%–50%,  $dI/dt=0.1\text{ A}/\mu\text{s}$ )

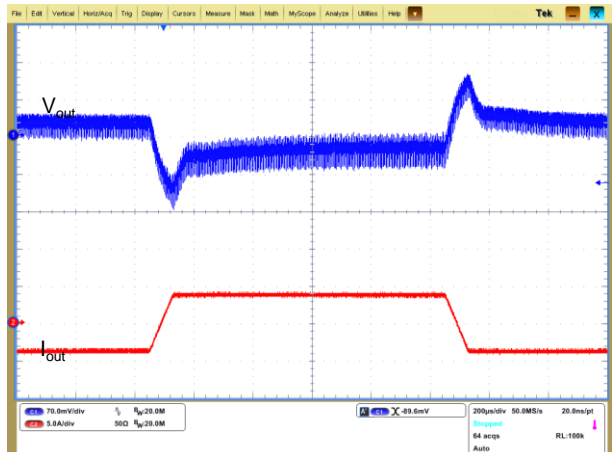
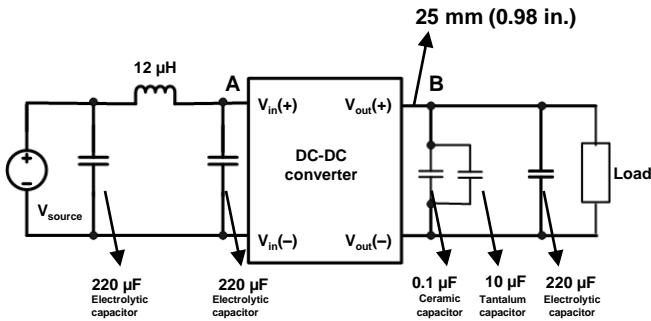

Figure 13: Test set-up diagram



**NOTE**

1. During the test of input reflected ripple current, the input terminal must be connected to a 12 µH inductor and a 220 µF electrolytic capacitor.
2. Point B, which is for testing the output voltage ripple, is 25 mm (0.98 in.) away from the V<sub>out</sub>(+) pin.

**Conditions:**  $T_A = 25^\circ\text{C}$  (77°F),  $V_{in} = 48\text{ V}$ ,  $V_{out} = 12\text{ V}$ ,  $I_{out} = 25\text{ A}$ .

Figure 14: Input reflected ripple current (for point A in the test set-up diagram)

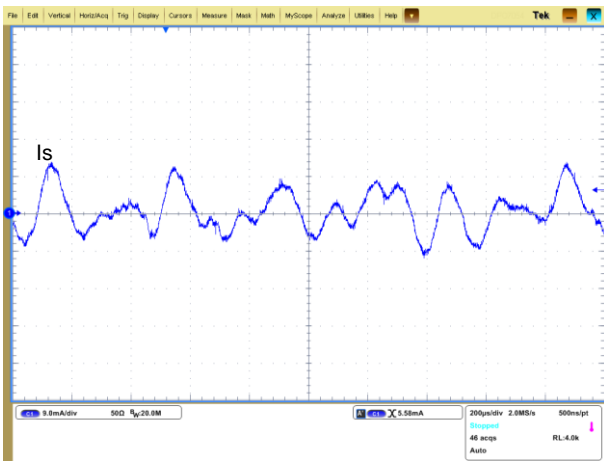
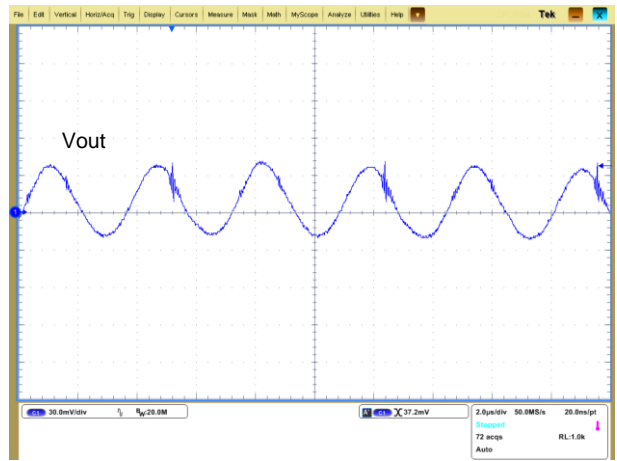

Figure 15: Output voltage ripple (for point B in the test set-up diagram)



## Feature Description

### Remote On/Off

Logic Enable	On/Off Pin Level	Status
Negative logic	Low level	Started
	High level or left open	Shut down

The following are some circuits for driving the on/off pin.

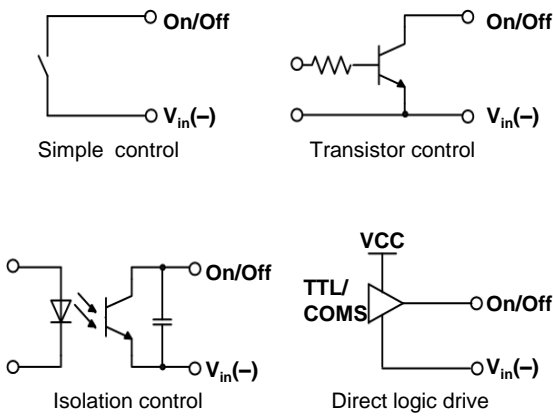

### Remote Sense

This function is used to compensate for voltage drops on circuits.

The Sense(+), Sense(-),  $V_{out}(+)$ , and  $V_{out}(-)$  terminals should meet the following requirements:

$$[V_{out}(+) - V_{out}(-)] - [\text{Sense}(+) - \text{Sense}(-)] \leq 10\% \times V_{nom} \quad (V_{nom} \text{ is the rated output voltage.})$$

If the remote sense function is disabled, the Sense(+) terminal connects to the  $V_{out}(+)$  terminal and the Sense(-) terminal connects to the  $V_{out}(-)$  terminal at the output end.

Figure 16: Configuration diagram for remote sense

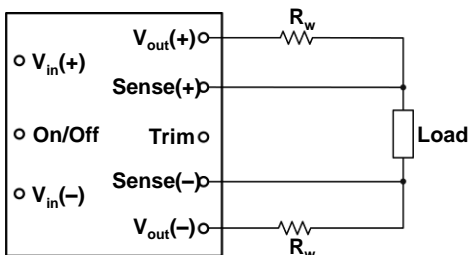

$R_w$  indicates the line impedance between the output end and the load.

### Output Voltage Trim

The output voltage can be adjusted within the range of 90%  $V_{nom}$  to 110%  $V_{nom}$  using a trim pin.

#### NOTE

If the trim pin is not used, it should be left open.

#### Trim Up

The output voltage can be increased by installing an external resistor between the trim pin and the Sense(+) terminal.

Figure 15: Configuration diagram for raising the output voltage

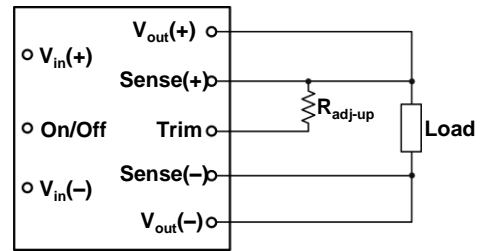

The following formula reflects the relationship between  $R_{adj-up}$  and  $V_{out}$ :

$$R_{adj-up} = \frac{5.1 \times V_{nom} \times (100 + \Delta)}{1.225 \times \Delta} - \frac{510}{\Delta} - 10.2(\text{kohm})$$

$$\text{Where, } \Delta = \frac{V_{trim-up} - V_{nom}}{V_{nom}} \times 100$$

#### NOTE

Although the output voltage can be increased by both the remote sense and trim functions, the maximum increase in the output voltage is the larger value, rather than the sum of both values.

The GAQ25S12B loading capability decreases as the voltage increases. Therefore, you need to ensure that the actual output power does not exceed the maximum output power when raising the voltage.

#### Trim Down

The output voltage can be decreased by installing an external resistor between the trim pin and the Sense(-) terminal.



Figure 16: Configuration diagram for lowering the output voltage

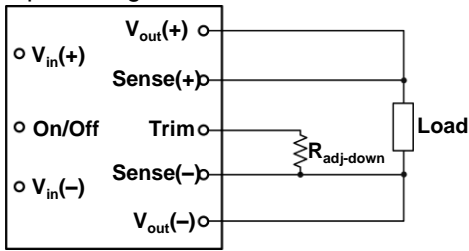

The following formula reflects the relationship between  $R_{adj-down}$  and  $V_{out}$ :

$$R_{adj-down} = \frac{510}{\Delta} - 10.2(kohm)$$

$$\text{Where, } \Delta = \frac{V_{nom} - V_{trim-down}}{V_{nom}} \times 100$$

### Input Undervoltage Protection

The GAQ25S12B is shut down after the input voltage drops below the undervoltage protection threshold for shutdown. The GAQ25S12B starts to work again after the input voltage reaches the input undervoltage protection threshold for startup.

### Output Overcurrent Protection

When the output current exceeds the overcurrent protection threshold, the GAQ25S12B works in hiccup mode until overcurrent disappears. After the output current drops to the specified range, the GAQ25S12B starts to work in normal mode.

### Output Overvoltage Protection

When the output voltage exceeds the overvoltage protection threshold, the GAQ25S12B works in hiccup mode.

### Overtemperature Protection

The overtemperature function protects the GAQ25S12B from being damaged at high temperatures. When the GAQ25S12B temperature exceeds the overtemperature protection threshold, the output is disabled. After the GAQ25S12B temperature drops below the threshold, the GAQ25S12B starts to work again.

### MTBF

The MTBF is calculated according to the Telcordia, SR332 Method 1 Case3. If the GAQ25S12B is used at 40°C (104°F), the airflow over it can be increased to retain the MTBF.

### Recommended Reverse Polarity Protection Circuit

Reverse polarity protection is recommended under installation and cabling conditions where reverse polarity across the input may occur.

Figure 17: Recommended reverse polarity protection circuits

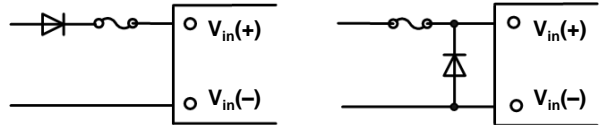

### Recommended Fuse

The GAQ25S12B has no internal fuse, but connects to an external fuse in actual use. To meet safety and regulatory requirements, a 20 A fuse is recommended.

#### NOTE

The fuse current should be 1.5 to 2 times the maximum operating current in actual use.

### EMC

For the acceptance standard, see the *DC-DC Converter EMC Acceptance Manual*.

Figure 18: EMC test set-up diagram

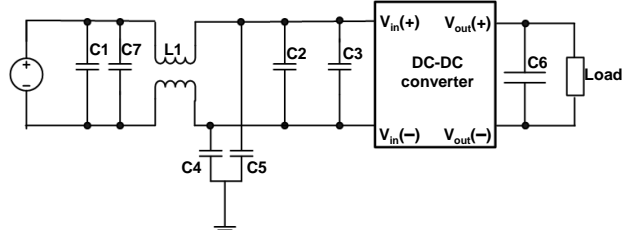

C1, C7: Surface mount device (SMD) ceramic capacitor (100 V/1000 nF/X7R/1210)

C2: SMD ceramic capacitor (100 V/100 nF/±10%/X7R/1206)

L1: Common-mode inductor (single phase, 809 μH/±25%/9.7 A/R5K/ 28 mm x 26 mm x 12.7 mm [1.10 in. x 1.02 in. x 0.50 in.]). The chip component with the same specifications can also be used.

C4: Plug-in film safety regulation capacitor (0.1 U/250 V), meeting the 1 kV pressure resistance requirement.

C5: High-pressure resistant chip ceramic capacitor (100nF/1000 V/X7R/2220). Chip ceramic capacitors are preferred.

C3: Electrolytic capacitor (220 μF/100 V)

C6: Electrolytic capacitor (220 μF/25V)

## Typical Application

Figure 19: Typical circuit applications

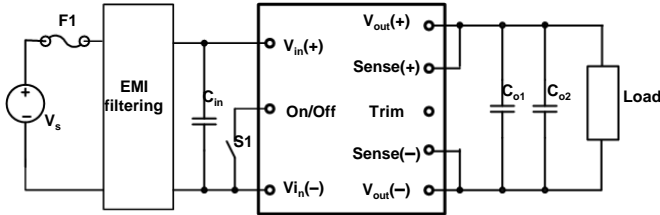

F1: 20 A fuse (fast blowing)

C<sub>in</sub>: The high-frequency, low equivalent series resistance (ESR) electrolytic capacitor (220 μF /100 V) is recommended.

C<sub>o1</sub>: The 1 μF ceramic capacitor is recommended.

C<sub>o2</sub>: The 220 μF electrolytic capacitor is recommended.

### NOTE

GAH25S12B cannot be connected in parallel.

## Thermal Consideration

Sufficient airflow should be provided to help ensure reliable operating of the GAQ25S12B. Therefore, thermal components are mounted on the top surface of the GAQ25S12B to dissipate heat to the surrounding environment by conduction, convection and radiation. Proper airflow can be verified by measuring the temperature at the middle of the baseplate.

Figure 20: Thermal test point

Middle of the base plate

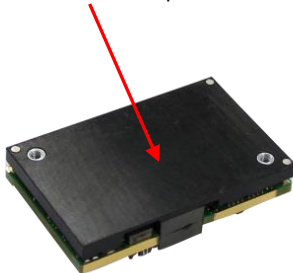

### NOTE

The temperature at the thermal test point on the GAQ25S12B cannot exceed 105°C (221°F). Otherwise, the GAQ25S12B will be protected against overtemperature and will not operate properly.

## Power Dissipation

The GAQ25S12B power dissipation is calculated based on efficiency. The following formula reflects the relationship between the consumed power ( $P_d$ ), efficiency ( $\eta$ ), and output power ( $P_o$ ):

$$P_d = P_o(1-\eta)/\eta$$

## Mechanical Considerations

### Installation

Although the GAQ25S12B can be mounted in any direction, free airflow must be taken. Normally power components are always installed at the end of the airflow path or have separate airflow paths. The installation mode helps keep other system equipment cooler and increase component service life.

### Soldering

The GAH25S12B is compatible with standard wave soldering techniques. During wave soldering, the setting parameters should base on the speciality of using flux, such as the preheating temperature and time, the soldering temperature and time and so on. To improve the soldering heighten, it is allowed to improve the preheating and soldering temperature, prolong the preheating and soldering time as the larger thermal capacity of the module. However, it is not allowed to exceed the high temperature limitation of the components that belong to the module.

When soldering the GAH25S12B, ensure that the soldering iron is at 425°C (797°F) and contacts pins for a maximum of 3 seconds, because long-time soldering at high temperatures may cause the GAH25S12B interior to be damaged.

The GAH25S12B can be rinsed using the isopropyl alcohol (IPA) solvent or other proper solvents.