

GAQ40S1V5

DC-DC Converter Technical Manual V1.4

Quarter-Brick
DC-DC Converter

36 - 75 V
Input

1.5 V Output

40 A Current

Negative
Logic

Description

The GAQ40S1V5 is a new generation isolated DC-DC converter that uses an industry standard quarter-brick structure, and features high efficiency and power density, operates from an input voltage range of 36 V to 75 V, provides the rated output voltage of 1.5 V and the maximum output current of 40 A.

Operational Features

- Input voltage: 36 - 75 V
- Output current: 0 - 40 A
- Low output ripple and noise
- Efficiency: 90.5% (1.5 V, 40 A)

Mechanical Features

- Industry standard quarter-brick (D x W x H): 57.9 mm x 36.8 mm x 9.7 mm (2.28 in. x 1.45 in. x 0.38 in.)
- Weight: about 37 g

Protection Features

- Input undervoltage protection
- Output overcurrent protection (hiccup mode)
- Output short circuit protection (hiccup mode)
- Output overvoltage protection (hiccup mode)
- Overtemperature protection (self-recovery)

Control Features

- Remote on/off
- Remote sense
- Output voltage trim

Safety Features

- UL60950-1 and CSA C22.2 No. 60950-1-07
- Meet UL94V-0 flammability requirements
- RoHS6 compliant



GAQ40S1V5

GAQ40S1V5

DC-DC Converter Technical Manual V1.4

Designation Explanation

$\frac{GAQ}{1}$ $\frac{40}{2}$ $\frac{S}{3}$ $\frac{1V5}{4}$

- 1 — 48Vin, high performance, analog control quarter-brick
- 2 — Output current: 40 A
- 3 — Single output
- 4 — Output voltage: 1.5 V

Mechanical Diagram

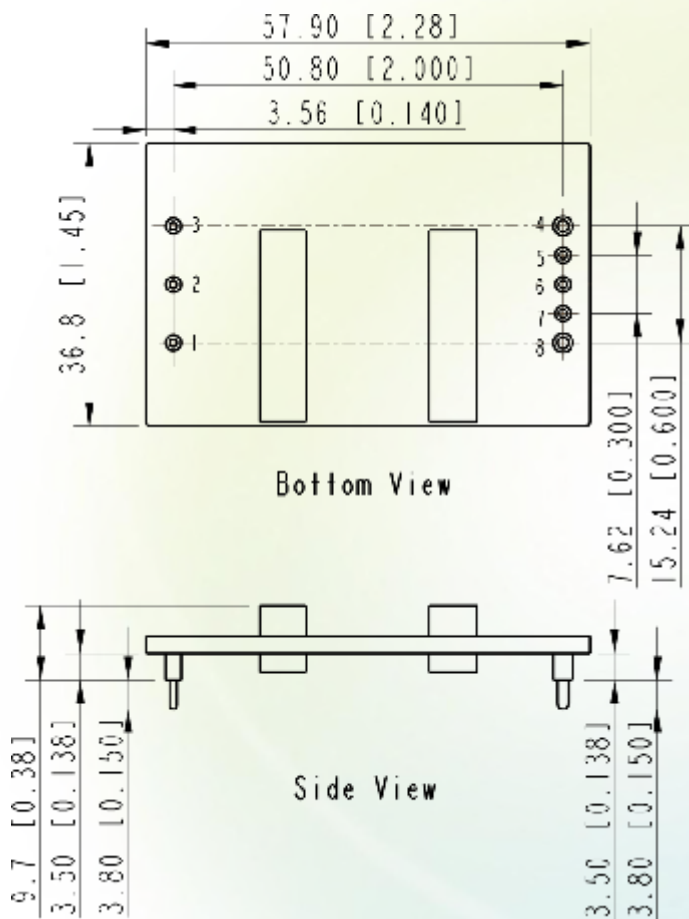

Pin Description

Pin No.	Function
1	$V_{in} (+)$
2	On/Off
3	$V_{in} (-)$
4	$V_{out} (-)$
5	Sense (-)
6	Trim
7	Sense (+)
8	$V_{out} (+)$

NOTE

- All dimensions in mm [in.]
Tolerances: $x.x \pm 0.5$ mm [$x.xx \pm 0.02$ in.]
 $x.xx \pm 0.25$ mm [$x.xxx \pm 0.010$ in.]
- Pin 1-3, 5-7 are 1.00 ± 0.05 mm [0.040 ± 0.002 in.] diameter with 2.00 ± 0.10 mm [0.080 ± 0.004 in.] diameter standoff shoulders.
Pin 4 and pin 8 are 1.50 ± 0.05 mm [0.060 ± 0.002 in.] diameter with 2.50 ± 0.10 mm [0.098 ± 0.004 in.] diameter standoff shoulders.

GAQ40S1V5

DC-DC Converter Technical Manual V1.4

Electrical Specifications

Conditions: $T_A = 25^\circ\text{C}$ (77°F), Airflow = 1 m/s (200 LFM), $V_{in} = 48\text{ V}$, unless otherwise notes.

Parameter	Min.	Typ.	Max.	Units	Notes & Conditions
Absolute maximum ratings					
Input voltage					
Continuous	-	-	80	V	-
Transient (100 ms)	-	-	100	V	-
Operating ambient temperature	-40	-	85	°C	See the thermal derating curve
Storage temperature	-55	-	125	°C	-
Operating humidity	5	-	95	% RH	Non-condensing
Input characteristics					
Operating input voltage	36	48	75	V	-
Maximum input current	-	-	2	A	$V_{in} = 36\text{ V}; I_{out} = 40\text{ A}$
No-load loss	-	2	-	W	$V_{in} = 48\text{ V}; I_{out} = 0\text{ A}$
Input capacitance	47	100	-	μF	Aluminum electrolytic capacitor
Inrush transient	-	-	1	A ² s	-
Input reflected ripple current (peak to peak)	-	-	20	mA	Oscilloscope bandwidth: 20 MHz
Output characteristics					
Output voltage set point	1.48	1.50	1.52	V	$V_{in} = 36 - 75\text{ V}; I_{out} = 40\text{ A}$
Output power	0	-	60	W	-
Output line regulation	-	-	±0.20	%	$V_{in} = 36 - 75\text{ V}; I_{out} = 40\text{ A}$
Output load regulation	-	-	±0.30	%	$V_{in} = 48\text{ V}; I_{out} = 0 - 40\text{ A}$
Regulated voltage precision	-	-	±3	%	$V_{in} = 36 - 75\text{ V}; I_{out} = 0 - 40\text{ A}$
Temperature coefficient	-	-	0.02	% $V_{out} / ^\circ\text{C}$	$T_A = -40^\circ\text{C}$ to $+85^\circ\text{C}$ (-40°F to $+185^\circ\text{F}$)
External capacitance	470	-	10 ⁴	μF	-
Output current	0	-	40	A	-
Output ripple and noise (peak to peak)	-	50	100	mV	Oscilloscope bandwidth: 20 MHz
Output voltage Trim range	80	-	110	%	-
Output voltage overshoot	-	-	5	%	The whole range of V_{in} , I_{out} and T_A
Output voltage rise time	-	2	6	ms	The whole range of V_{in} , I_{out} and T_A
Switching frequency	-	280	-	kHz	-

GAQ40S1V5

DC-DC Converter Technical Manual V1.4

Electrical Specifications

Conditions: $T_A = 25^\circ\text{C}$ (77°F), Airflow = 1 m/s (200 LFM), $V_{in} = 48\text{ V}$, unless otherwise notes.

Parameter	Min.	Typ.	Max.	Units	Notes & Conditions
Protection characteristics					
Input undervoltage protection					
Startup threshold	31	34	36	V	-
Shutdown threshold	30	33	35	V	-
Hysteresis	1	2	3	V	-
Output overcurrent protection	42	-	60	A	Hiccup mode
Output short circuit protection	-	-	-	-	Hiccup mode
Output overvoltage protection	1.8	-	2.5	V	Hiccup mode
Overtemperature protection					Self-recovery
Threshold	115	125	135	$^\circ\text{C}$	The values are obtained by measuring the temperature of the hottest power component on the top surface of the convertor
Hysteresis	5	-	-	$^\circ\text{C}$	
Dynamic characteristics					
Overshoot amplitude	-	-	75	mV	Current change rate: 0.1 A/ μs load : 25% - 50% - 25%; 50% - 75% - 50%
Recovery time	-	-	400	μs	
Overshoot amplitude	-	-	200	mV	Current change rate: 1 A/ μs load : 25% - 50% - 25%; 50% - 75% - 50%
Recovery time	-	-	400	μs	
Efficiency					
100% load	87.0	90.5	-	%	$V_{in} = 48\text{ V}$; $I_{out} = 40\text{ A}$; $T_A = 25^\circ\text{C}$ (77°F)
50% load	88.0	91.5	-	%	$V_{in} = 48\text{ V}$; $I_{out} = 20\text{ A}$; $T_A = 25^\circ\text{C}$ (77°F)
20% load	-	87.0	-	%	$V_{in} = 48\text{ V}$; $I_{out} = 8\text{ A}$; $T_A = 25^\circ\text{C}$ (77°F)
Isolation characteristics					
Input-to-output Isolation voltage	-	-	1500	V DC	Functional Isolation
Other characteristics					
Remote on/off voltage					
Low level	-0.7	-	1.2	V	-
High level	3.5	-	12	V	-
On/Off current					
Low level	-	-	1.0	mA	-
High level	-	-	-	μA	-
Reliability characteristics					
Mean time between failures (MTBF)	-	1.5	-	Million hours	Telcordia SR332; 80% load; Airflow = 1.5m/s (300LFM); $T_A = 40^\circ\text{C}$ (104°F)

GAQ40S1V5

DC-DC Converter Technical Manual V1.4

Characteristic Curves

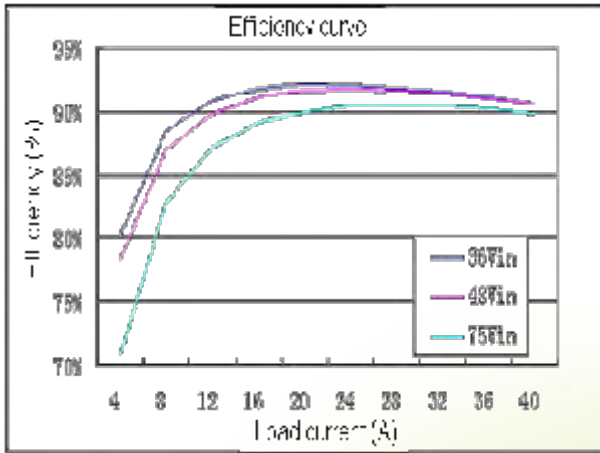

Figure 1: Efficiency ($T_A = 25^\circ\text{C}$ or 77°F)

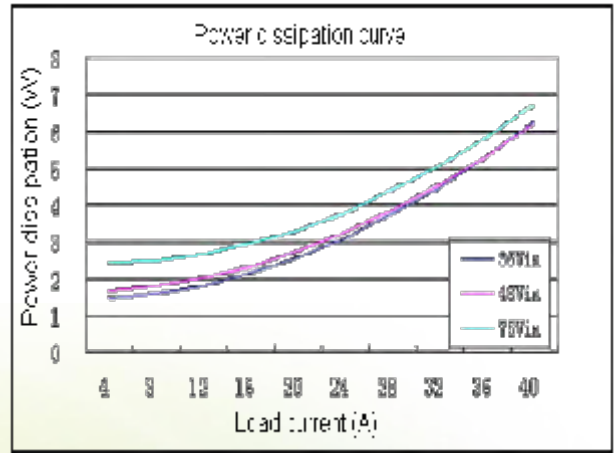

Figure 2: Power dissipation ($T_A = 25^\circ\text{C}$ or 77°F)

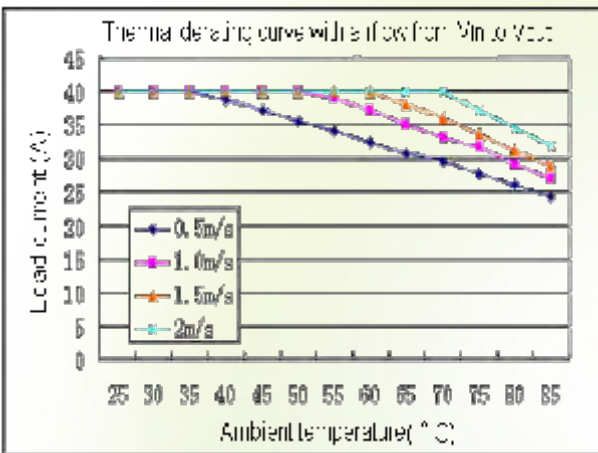

Figure 3: Thermal derating with airflow from V_{in} to V_{out} ($V_{in} = 48\text{ V}$; $V_{out} = 1.5\text{ V}$)

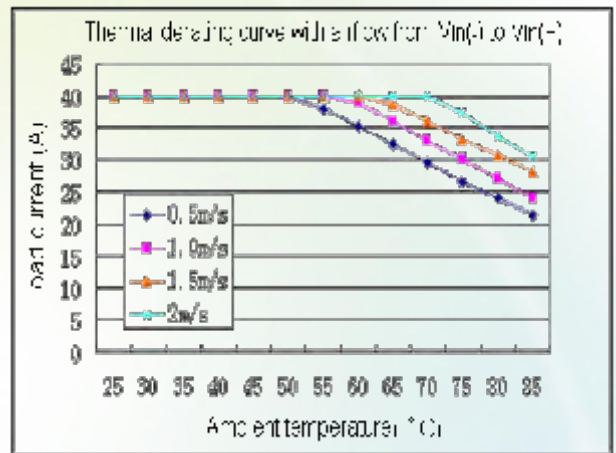

Figure 4: Thermal derating with airflow from $V_{in}(+)$ to $V_{in}(-)$ ($V_{in} = 48\text{ V}$; $V_{out} = 1.5\text{ V}$)

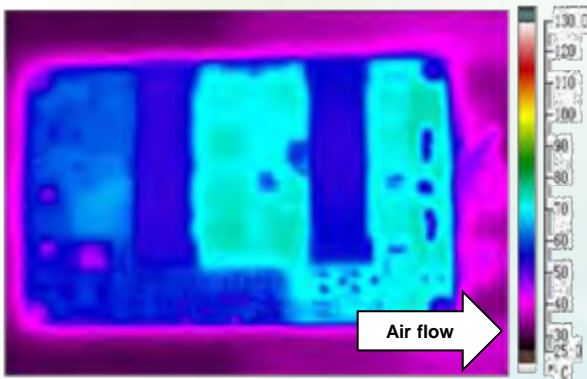

Figure 5: Thermal plot with airflow from V_{in} to V_{out} ($T_A = 25^\circ\text{C}$ (77°F); Airflow = 1 m/s (200 FLM); $V_{in} = 48\text{ V}$; $V_{out} = 1.5\text{ V}$; $I_{out} = 40\text{ A}$)

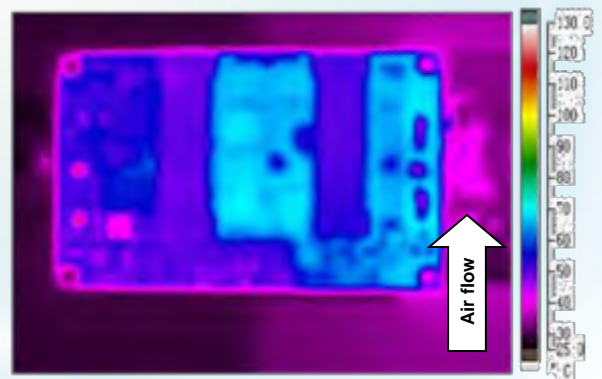

Figure 6: Thermal plot with airflow from $V_{in}(+)$ to $V_{in}(-)$ ($T_A = 25^\circ\text{C}$ (77°F); Airflow = 1 m/s (200 FLM); $V_{in} = 48\text{ V}$; $V_{out} = 1.5\text{ V}$; $I_{out} = 40\text{ A}$)

GAQ40S1V5

DC-DC Converter Technical Manual V1.4

Typical Waveforms



NOTE

1. During the test of input reflected ripple current, the input terminal must be connected to a 12 μH inductor and a 220 μF electrolytic capacitor.
2. Point B, which is for testing the output voltage ripple, is 25 mm (0.98 in.) away from the $V_{\text{out}(+)}$ pin.

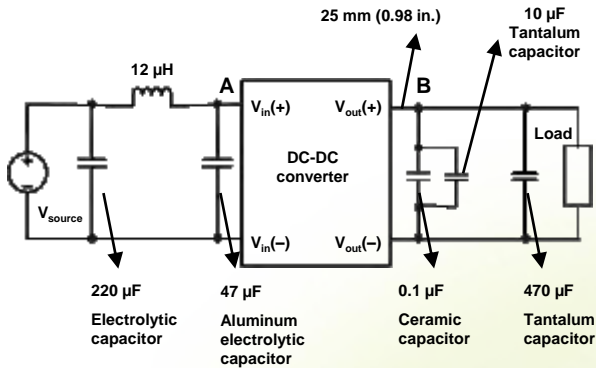

Figure 7: Test set-up diagram

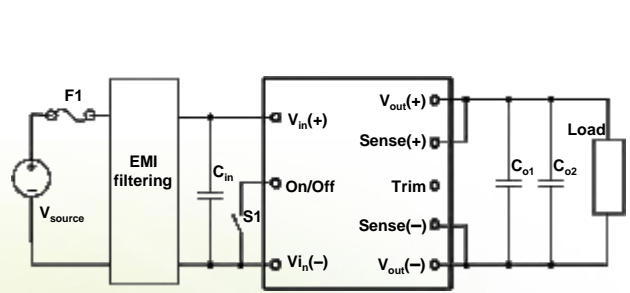

Figure 8: Typical circuit applications

F1: 4 A fuse (fast blowing)

C_{in} : The high-frequency, low equivalent series resistance (ESR) electrolytic capacitor (100 $\mu\text{F}/100\text{ V}$) is recommended.

C_{01} : The 1 μF ceramic capacitor is recommended.

C_{02} : The 470 μF tantalum capacitor is recommended.

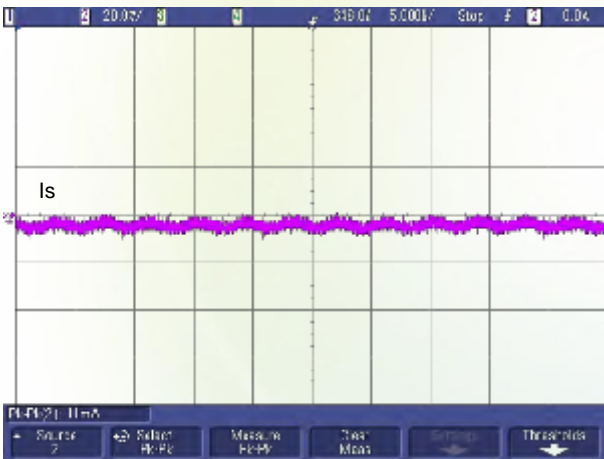

Figure 9: Input reflected ripple current (for point A in the test set-up diagram, $V_{\text{in}} = 48\text{ V}$, $V_{\text{out}} = 1.5\text{ V}$, $I_{\text{out}} = 40\text{ A}$)

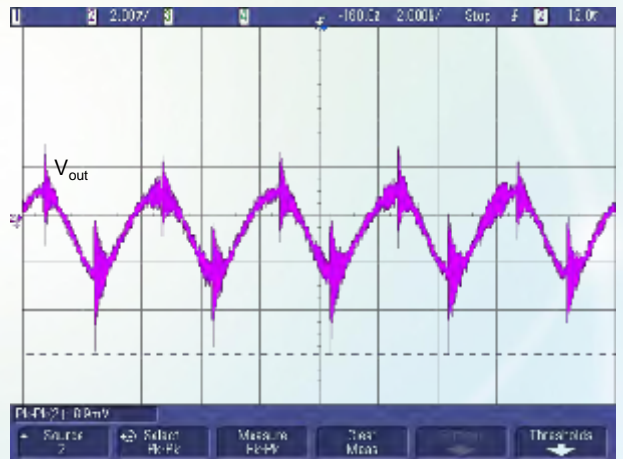

Figure 10: Output voltage ripple (for point B in the test set-up diagram, $V_{\text{in}} = 48\text{ V}$, $V_{\text{out}} = 1.5\text{ V}$, $I_{\text{out}} = 40\text{ A}$)

GAQ40S1V5

DC-DC Converter Technical Manual V1.4

Typical Waveforms

Conditions: $T_A = 25^\circ\text{C}$ (77°F), $V_{in} = 48\text{ V}$.

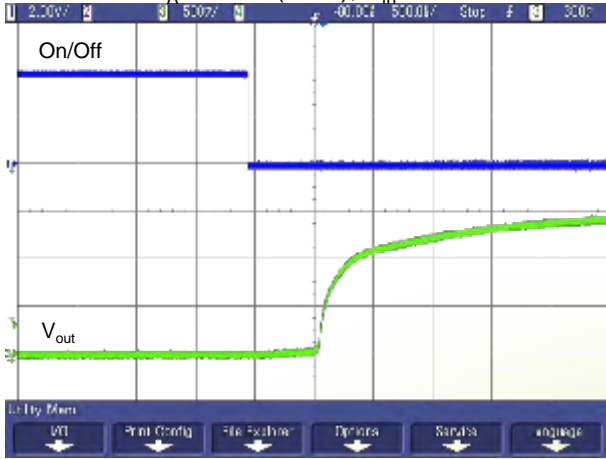

Figure 11: Startup from On/Off

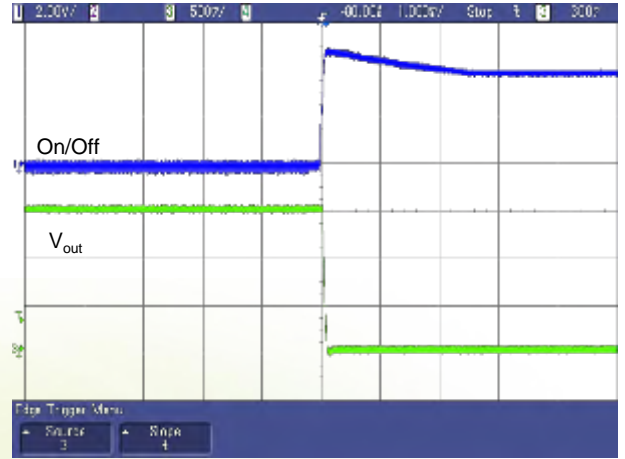

Figure 12: Shutdown from On/Off

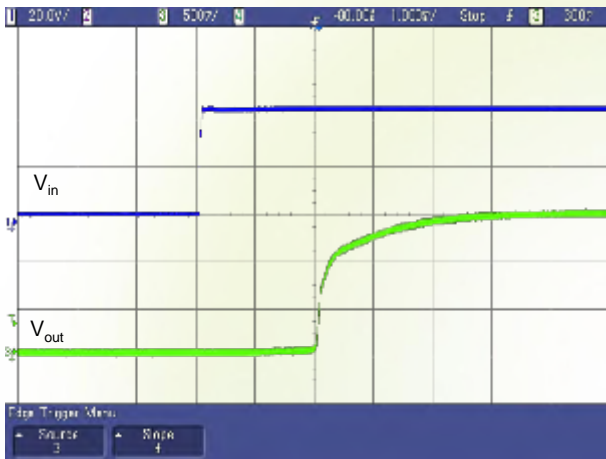

Figure 13: Startup by power on

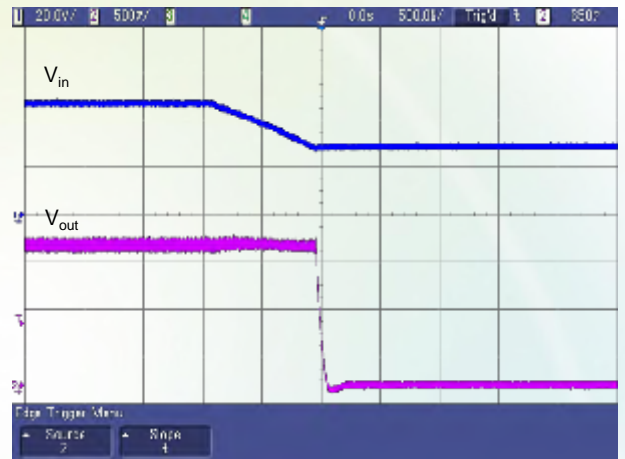

Figure 14: Shutdown by power off

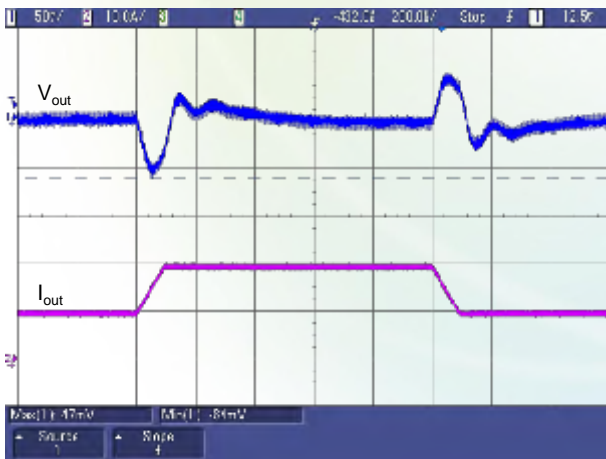

Figure 15: Output voltage dynamic response
(Load: 25% - 50% - 25%, $di/dt=0.1\text{ A}/\mu\text{s}$)

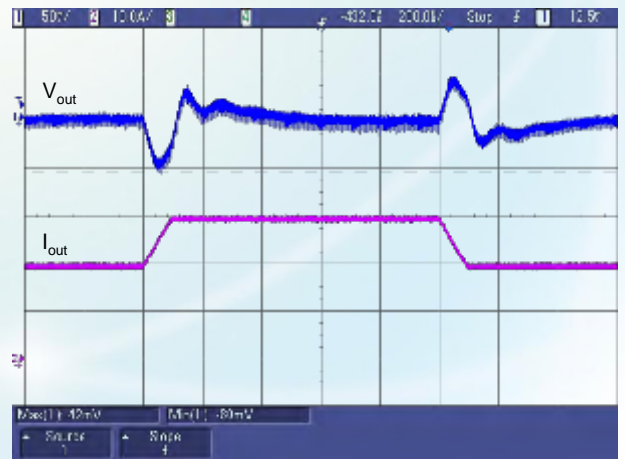

Figure 16: Output voltage dynamic response
(Load: 50% - 75% - 50%, $di/dt=0.1\text{ A}/\mu\text{s}$)

Remote On/Off

Logic Enable	On/Off Pin Level	Status
Negative logic	Low level	On
	High level or left open	Off

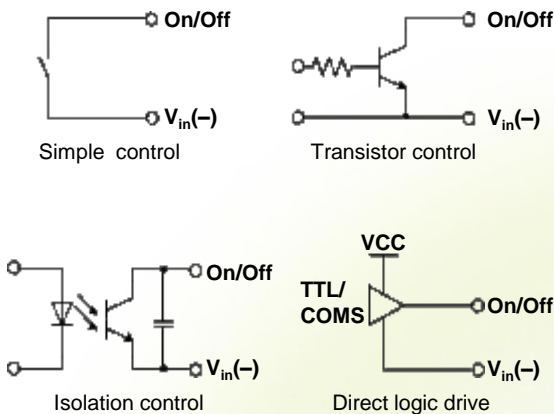

Figure 17: various circuits for driving the On/Off pin

Remote Sense

This function is used to compensate for voltage drops on R_w . The Sense(+), Sense(-), $V_{out}(+)$, and $V_{out}(-)$ terminals should meet the following requirements:

$$[V_{out}(+) - V_{out}(-)] - [Sense(+) - Sense(-)] \leq 10\% \times V_{nom}$$

(V_{nom} is the rated output voltage.)

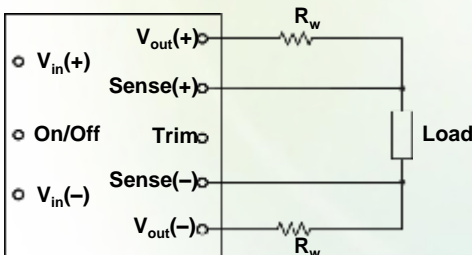

Figure 18: Configuration diagram for remote sense

R_w indicates the line impedance between the output terminal and the load.

If the remote sense function is disabled, the Sense(+) terminal directly connects to the $V_{out}(+)$ terminal and the Sense(-) terminal directly connects to the $V_{out}(-)$ terminal.

Output Voltage Trim

The output voltage can be adjusted according to the trim range specification by using the Trim pin.

Trim Up

The output voltage can be increased by installing an external resistor between the Trim pin and the Sense(+) pin.

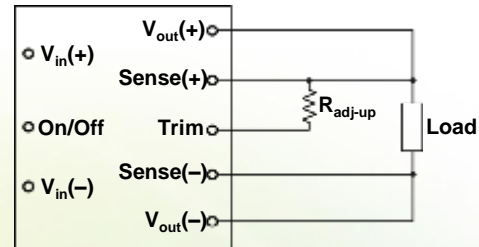

Figure 19: Configuration diagram for Trim up

The relationship between R_{adj-up} and V_{out} :

$$R_{adj-up} = \frac{5.1 \times V_{nom} \times (100 + \Delta)}{1.225 \times \Delta} - \frac{510}{\Delta} - 10.2(\text{kohm})$$

$$\Delta = \frac{V_{trim-up} - V_{nom}}{V_{nom}} \times 100$$

NOTE

1. If the Trim pin is not used, it should be left open.
2. Ensure that the actual output power does not exceed the maximum output power when raising the voltage.

Trim Down

The output voltage can be decreased by installing an external resistor between the Trim pin and the Sense(-) pin.

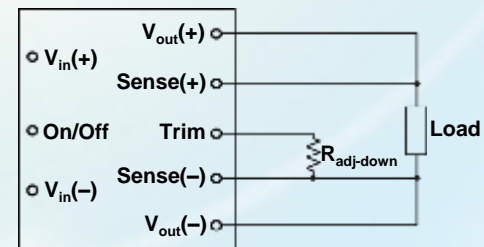

Figure 20: Configuration diagram for Trim down

The relationship between $R_{adj-down}$ and V_{out} :

$$R_{adj-down} = \frac{510}{\Delta} - 10.2(\text{kohm}) \quad \Delta = \frac{V_{nom} - V_{trim-down}}{V_{nom}} \times 100$$

GAQ40S1V5

DC-DC Converter Technical Manual V1.4

Input Undervoltage Protection

The converter will shut down after the input voltage drops below the undervoltage protection threshold. The converter will start to work again after the input voltage reaches the input undervoltage protection threshold for startup. For the Hysteresis, see the Protection characteristics.

Output Overcurrent Protection

The converter equipped with current limiting circuitry can provide protection from an output overload or short circuit condition. If the output current exceeds the output overcurrent protection set point, the converter enters hiccup mode. When the fault condition is removed, the converter will automatically restart.

Output Overvoltage Protection

When the voltage directly across the output pins exceeds the output overvoltage protection threshold, the converter will enter hiccup mode. When the fault condition is removed, the converter will automatically restart.

Overtemperature Protection

A temperature sensor on the converter senses the average temperature of the module. It protects the converter from being damaged at high temperatures. When the temperature exceeds the overtemperature protection threshold, the output will shut down. It will allow the converter to turn on again when the temperature of the sensed location falls by the value of Overtemperature Protection Hysteresis.

MTBF

The MTBF is calculated according to the Telcordia, SR332 Method 1 Case3.

Recommend Reverse Polarity Protection Circuit

Reverse polarity protection is recommended under installation and cabling conditions where reverse polarity across the input may occur.

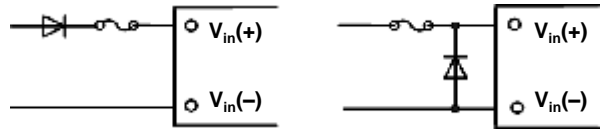

Figure 21: Recommend reverse polarity protection circuits

Recommended Fuse

The converter has no internal fuse. To meet safety and regulatory requirements, a 4 A fuse is recommended.

NOTE

The fuse current should be 1.5 to 2 times the maximum operating current in actual use.

EMC

For the acceptance standard, see the *DC-DC Converter EMC Acceptance Manual*.

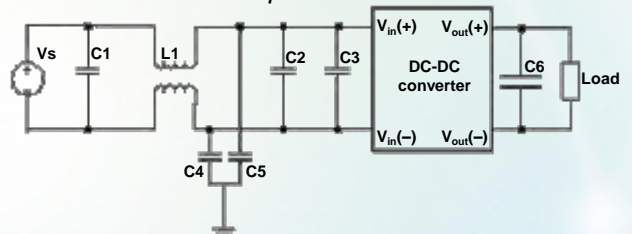

Figure 22: EMC test set-up diagram

C1: Surface mount device (SMD) ceramic capacitor (100 V/1000 nF/X7R/1210)

C2: SMD ceramic capacitor (100 V/100 nF/±10%/X7R/1206)

L1: Common-mode inductor (single phase, 1320 μH ±25%/4 A/R5K/ 21 mm x 21 mm x 12.5 mm [0.83 in. x 0.83 in. x 0.49 in.]). The chip component with the same specifications can also be used.

C4, C5: High-pressure resistant chip ceramic capacitor (22 nF /1000 V/X7R/1210)

C3: Electrolytic capacitor (100 μF /100 V)

C6: Tantalum capacitor (470 μF /25 V)

GAQ40S1V5

DC-DC Converter Technical Manual V1.4

Qualification Testing

Parameter	Units	Condition
High Accelerated Life Test (HALT)	4	Lowest operating temperature: -60°C (-76°F); highest operating temperature: 120°C (248°F); vibration limit: 40 G
Proof Of Screen (POS)	4	80 temperature cycles; 50% vibration limit stress: 20 G
High Accelerated Stress Audit (HASA)	8	4 temperature cycles; 50% vibration limit stress: 20 G
Thermal Shock	32	500 temperature cycles between -40°C (-40°F) and +125°C (+257°F) with the temperature change rate of 20°C (68°F) per minute Lasting for 30 minutes both at -40°C (-40°F) and +125°C (+257°F)
Temperature Humidity Bias	16	85°C (185°F); 85% RH; 1000 operating hours under lowest load power

Thermal Consideration

Thermal Test Point

Sufficient airflow should be provided to ensure reliable operating of the converter. Therefore, thermal components are mounted on the top surface of the converter to dissipate heat to the surrounding environment by conduction, convection and radiation. Proper airflow can be verified by measuring the temperature at part 1 and part 2 in the Figure 23.

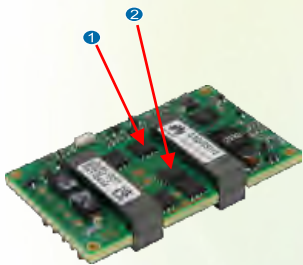

Figure 23: Thermal test point

NOTE

The temperature at the thermal test point on the converter cannot exceed 125°C (257°F). Otherwise, the converter will be protected against overtemperature and will not operate properly.

Power Dissipation

The converter power dissipation is calculated based on efficiency. The following formula reflects the relationship between the consumed power (P_d), efficiency (η), and output power (P_o): $P_d = P_o(1-\eta)/\eta$

GAQ40S1V5

DC-DC Converter Technical Manual V1.4

Mechanical Consideration

Installation

Although the converter can be mounted in any direction, free airflow must be taken.

Soldering

The converter is compatible with standard wave soldering techniques. When wave soldering, the converter pins should be preheated for 20 - 30 seconds at 110°C (230°F) , and wave soldered at 260°C (500°F) for less than 10 seconds.

When hand soldering, the iron temperature should be maintained at 425°C (797°F) and applied to the converter pins for less than 5 seconds.

The converter can be rinsed using the isopropyl alcohol (IPA) solvent or other proper solvents.

HUAWEI TECHNOLOGIES CO., LTD.
Huawei Industrial Base Bantian Longgang
Shenzhen 518129
People's Republic of China
www.huawei.com