

# GAQ45D3315

## DC-DC Converter Technical Manual V1.4

Quarter-Brick DC-DC Converter	36 - 75 V Input	3.3 V / 8 A Output	1.5 V / 12 A Output	45 W Power	Negative Logic
----------------------------------	--------------------	-----------------------	------------------------	---------------	-------------------

### Description

The GAQ45D3315 is a new generation isolated DC-DC converter that uses an industry standard quarter-brick structure, and features high efficiency and power density, operates from an input voltage range of 36 V to 75 V, provides the rated output voltage of 3.3 V and 1.5 V and the rated output power of 45 W.

### Operational Features

- Input voltage: 36 - 75 V
- Output current: 0 - 8 A(3.3 V); 0 - 12 A(1.5 V)
- Output ripple and noise: 50 mV
- Efficiency: 88.0% (3.3 V, 8 A; 1.5 V, 12 A)

### Mechanical Features

- Industry standard quarter-brick (D x W x H): 57.9 mm x 36.8 mm x 10.2 mm (2.28 in. x 1.45 in. x 0.40 in.)
- Weight: about 50 g

### Protection Features

- Input undervoltage protection
- Output overcurrent protection (hiccup mode)
- Output short circuit protection (hiccup mode)
- Output overvoltage protection (hiccup mode)
- Overtemperature protection (self-recovery)

### Control Features

- Remote on/off
- Output voltage trim

### Safety Features

- UL60950-1 and CSA C22.2 No. 60950-1-07
- Meet UL94V-0 flammability requirements
- RoHS6 compliant



**GAQ45D3315**

# GAQ45D3315

## DC-DC Converter Technical Manual V1.4

### Designation Explanation

GAQ 45 D 3315  
1 2 3 4

- 1 — 48Vin, high performance, analog control quarter-brick
- 2 — Output power: 45 W
- 3 — Double output
- 4 — Output voltage: 3.3 V, 1.5 V

### Mechanical Diagram

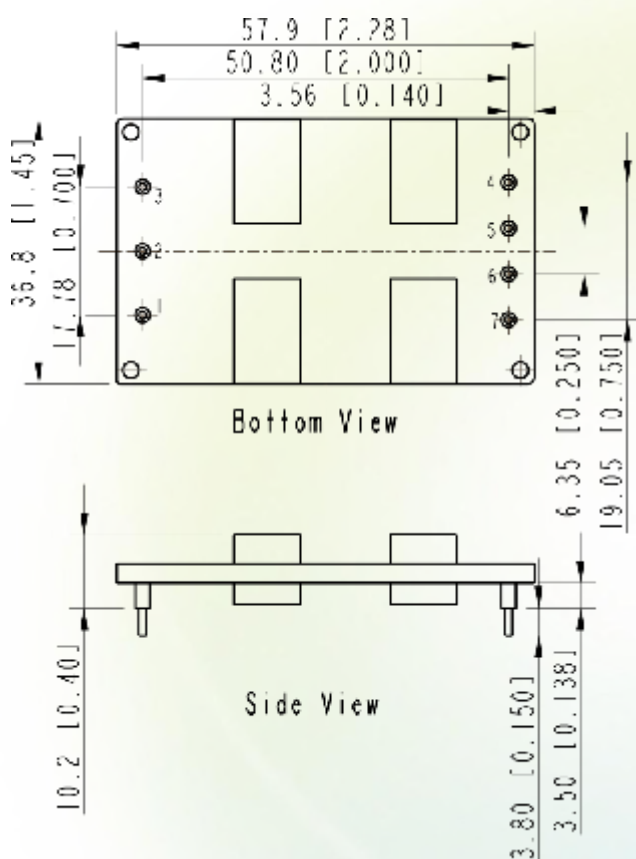

### Pin Description

Pin No.	Function
1	$V_{in} (+)$
2	On/Off
3	$V_{in} (-)$
4	$V_{out} (+)$ (1.5 V)
5	COM
6	Trim
7	$V_{out} (+)$ (3.3 V)

### NOTE

1. All dimensions in mm [in.]  
Tolerances:  $x.x \pm 0.5$  mm [ $x.xx \pm 0.02$  in.]  
 $x.xx \pm 0.25$  mm [ $x.xxx \pm 0.010$  in.]
2. Pin 1-7 are  $1.00 \pm 0.05$  mm [ $0.040 \pm 0.002$  in.] diameter with  $2.00 \pm 0.10$  mm [ $0.080 \pm 0.004$  in.] diameter standoff shoulders.

# GAQ45D3315

## DC-DC Converter Technical Manual V1.4

### Electrical Specifications

Conditions:  $T_A = 25^\circ\text{C}$  (77°F), Airflow = 1 m/s (200 LFM),  $V_{in} = 48\text{ V}$ , unless otherwise notes.

Parameter	Output	Min.	Typ.	Max.	Units	Notes & Conditions
<b>Absolute maximum ratings</b>						
Input voltage						
Continuous	-	-	-	80	V	-
Transient (100 ms)	-	-	-	100	V	-
Operating ambient temperature	-	-40	-	85	°C	See the thermal derating curve
Storage temperature	-	-55	-	125	°C	-
Operating humidity	-	5	-	95	% RH	Non-condensing
<b>Input characteristics</b>						
Operating input voltage	-	36	48	75	V	-
Maximum input current	-	-	-	2.0	A	$V_{in} = 36\text{ V}$ ; $I_{3.3Vout} = 8\text{ A}$ ; $I_{1.5Vout} = 12\text{ A}$
No-load loss	-	-	2.4	-	W	$V_{in} = 48\text{ V}$ ; $I_{3.3Vout} = 0\text{ A}$ ; $I_{1.5Vout} = 0\text{ A}$
Input capacitance	-	100	-	-	μF	Aluminum electrolytic capacitor
Inrush transient	-	-	-	1	A <sup>2</sup> s	-
Input reflected ripple current (peak to peak)	-	-	-	20	mA	Oscilloscope bandwidth: 20 MHz
<b>Output characteristics</b>						
Output voltage set point	3.3 V	3.30	3.33	3.36	V	$V_{in} = 48\text{ V}$ ; $I_{out} = 8\text{ A}$
	1.5 V	1.50	1.54	1.56	V	$V_{in} = 48\text{ V}$ ; $I_{out} = 12\text{ A}$
Output power	3.3 V 1.5 V	0	-	45	W	$V_{in} = 36 - 75\text{ V}$ ; $I_{3.3Vout} = 8\text{ A}$ ; $I_{1.5Vout} = 12\text{ A}$
Output line regulation	3.3 V 1.5 V	-	-	± 1.0	%	$V_{in} = 36 - 75\text{ V}$ ; $I_{3.3Vout} = 8\text{ A}$ ; $I_{1.5Vout} = 12\text{ A}$
Output load regulation	3.3 V 1.5 V	-	-	± 1.5	%	-
Across adjustment rate	3.3V 1.5 V	-	-	1.5	%	$I_{out1}=I_{out\_min}$ , $I_{out2}=120\%I_{out\_min}$ or $I_{out1}=I_{out\_max}$ , $I_{out2}=80\%I_{out\_max}$
Regulated voltage precision	3.3 V 1.5 V	-	-	± 3	%	The whole range of $V_{in}$ , $I_{out}$ and $T_A$
Temperature coefficient	3.3 V 1.5 V	-	-	0.02	% $V_{out}/^\circ\text{C}$	$T_A = -40^\circ\text{C}$ to $+85^\circ\text{C}$ ( $-40^\circ\text{F}$ to $+185^\circ\text{F}$ )
External capacitance	3.3 V	470	-	5000	μF	470 μF is Tantalum capacitor
	1.5 V	470	-	10 <sup>4</sup>	μF	470 μF is Tantalum capacitor

# GAQ45D3315

## DC-DC Converter Technical Manual V1.4

### Electrical Specifications

Conditions:  $T_A = 25^\circ\text{C}$  (77°F), Airflow = 1 m/s (200 LFM),  $V_{in} = 48\text{ V}$ , unless otherwise notes.

Parameter	Output	Min.	Typ.	Max.	Units	Notes & Conditions
<b>Output characteristics</b>						
Output current	3.3 V	0	-	8	A	-
	1.5 V	0	-	12	A	-
Output ripple and noise (peak to peak)	3.3 V	-	-	50	mV	Oscilloscope bandwidth: 20 MHz See BD point of Figure 7
	1.5 V	-	-	50	mV	Oscilloscope bandwidth: 20 MHz See CD point of Figure 7
Output voltage Trim range	-	80	-	110	%	-
Output voltage overshoot	3.3 V 1.5 V	-	-	±5	%	-
Output voltage rise time	3.3 V 1.5 V	-	-	20	ms	-
Output voltage delay time	3.3 V 1.5 V	-	-	20	ms	-
Switching frequency	-	-	320	-	kHz	-
<b>Protection characteristics</b>						
Input undervoltage protection	-	-	-	-	-	-
Startup threshold	-	31	-	36	V	-
Shutdown threshold	-	30	-	35	V	-
Hysteresis	-	1	-	3	V	-
Output overcurrent protection	3.3 V	9	-	14	A	Hiccup mode
	1.5 V	15	-	22	A	Hiccup mode
Output overvoltage protection	3.3 V	3.9	-	5.0	V	Hiccup mode
	1.5 V	1.77	-	2.26	V	Hiccup mode
Overtemperature protection	-	-	-	-	-	Self-recovery
Threshold	-	110	110	135	°C	The values are obtained by measuring the temperature of the hottest power component on the top surface of the convertor
Hysteresis	-	5	-	-	°C	

# GAQ45D3315

## DC-DC Converter Technical Manual V1.4

### Electrical Specifications

Conditions:  $T_A = 25^\circ\text{C}$  (77°F), Airflow = 1 m/s (200 LFM),  $V_{in} = 48\text{ V}$ , unless otherwise notes.

Parameter	Output	Min.	Typ.	Max.	Units	Notes & Conditions
<b>Dynamic characteristics</b>						
Overshoot amplitude	3.3 V	-	-	165	mV	Current change rate: 0.1 A/ $\mu\text{s}$ load : 25% - 50% - 25%; 50% - 75% - 50%①
Recovery time		-	-	400	$\mu\text{s}$	
Overshoot amplitude	1.5 V	-	-	90	mV	Current change rate: 0.1 A/ $\mu\text{s}$ load : 25% - 50% - 25%; 50% - 75% - 50%②
Recovery time		-	-	400	$\mu\text{s}$	
<b>Efficiency</b>						
100% load	-	86.0	88.0	-	%	$V_{in} = 48\text{ V}$ ; $I_{3.3Vout} = 8\text{ A}$ ; $I_{1.5Vout} = 12\text{ A}$
50% load	-	82.0	88.0	-	%	$V_{in} = 48\text{ V}$ ; $I_{3.3Vout} = 4\text{ A}$ ; $I_{1.5Vout} = 6\text{ A}$
<b>Isolation characteristics</b>						
Input-to-output Isolation voltage	-	-	-	1500	V DC	Functional Isolation
<b>Other characteristics</b>						
Remote on/off voltage						
Low level	-	-0.7	-	1.2	V	-
High level	-	3.5	-	12	V	-
On/Off current						
Low level	-	-	-	1.0	mA	-
High level	-	-	-	-	$\mu\text{A}$	-
<b>Reliability characteristics</b>						
Mean time between failures (MTBF)	-	-	1.5	-	Million hours	Telcordia SR332; 80% load; Airflow = 1.5m/s (300LFM); $T_A = 40^\circ\text{C}$ (104°F)

①: Connect a 470  $\mu\text{F}$  tantalum capacitor to the 3.3V<sub>out</sub> pin in parallel.

②: Connect a 470  $\mu\text{F}$  tantalum capacitor to the 1.5V<sub>out</sub> pin in parallel.



### Characteristic Curves

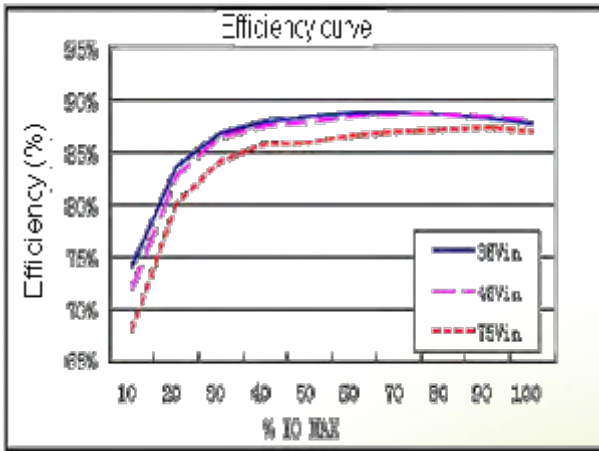

Figure 1: Efficiency ( $T_A = 25^\circ\text{C}$  or  $77^\circ\text{F}$ )

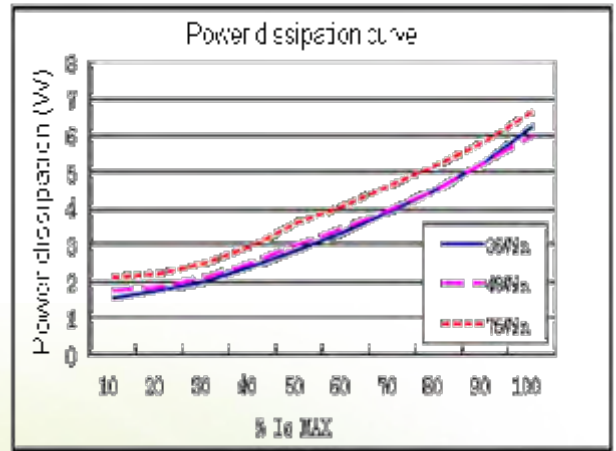

Figure 2: Power dissipation ( $T_A = 25^\circ\text{C}$  or  $77^\circ\text{F}$ )

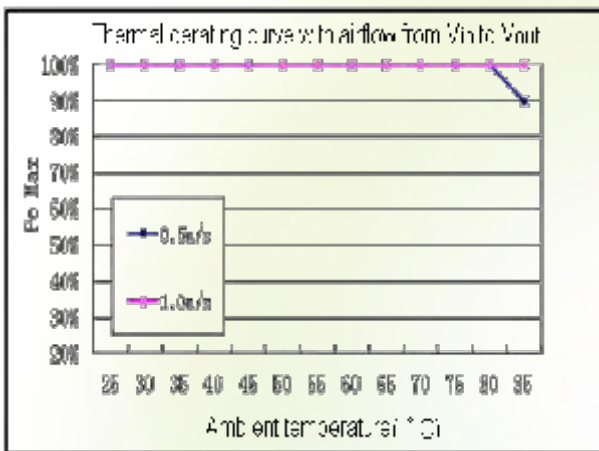

Figure 3: Thermal derating with airflow from  $V_{in}$  to  $V_{out}$  ( $V_{in} = 48\text{ V}$ ;  $I_{3.3Vout}$  and  $I_{1.5Vout}$  change synchronous, see erect axis)

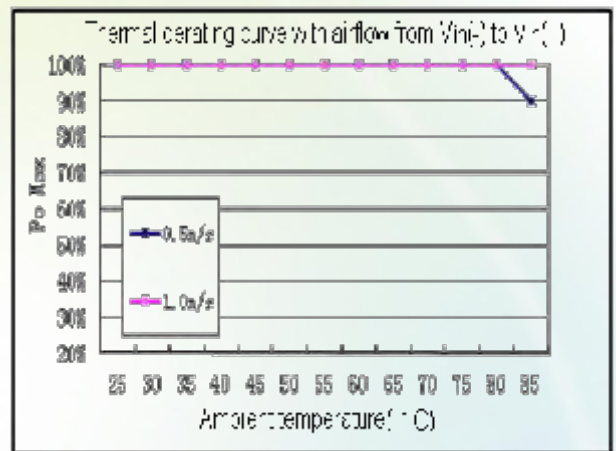

Figure 4: Thermal derating with airflow from  $V_{in}(-)$  to  $V_{in}(+)$  ( $V_{in} = 48\text{ V}$ ;  $I_{3.3Vout}$  and  $I_{1.5Vout}$  change synchronous, see erect axis)



Figure 5: Thermal plot with airflow from  $V_{in}$  to  $V_{out}$  ( $T_A = 25^\circ\text{C}$  ( $77^\circ\text{F}$ ); Airflow =  $1\text{ m/s}$  ( $200\text{ FLM}$ );  $V_{in} = 48\text{ V}$ ; Full load)



Figure 6: Thermal plot with airflow from  $V_{in}(-)$  to  $V_{in}(+)$  ( $T_A = 25^\circ\text{C}$  ( $77^\circ\text{F}$ ); Airflow =  $1\text{ m/s}$  ( $200\text{ FLM}$ );  $V_{in} = 48\text{ V}$ ; Full load)

# GAQ45D3315

## DC-DC Converter Technical Manual V1.4

### Typical Waveforms



#### NOTE

1. During the test of input reflected ripple current, the input terminal must be connected to a 12  $\mu\text{H}$  inductor and a 220  $\mu\text{F}$  electrolytic capacitor.
2. Point B, which is for testing the output voltage ripple, is 25 mm (0.98 in.) away from the 3.3V<sub>out</sub> pin.
3. Point C, which is for testing the output voltage ripple, is 25 mm (0.98 in.) away from the 1.5V<sub>out</sub> pin.
4. C<sub>out1</sub> and C<sub>out2</sub> are capacitors that connect a 10  $\mu\text{F}$  tantalum capacitor to a 0.1  $\mu\text{F}$  ceramic capacitor in parallel.

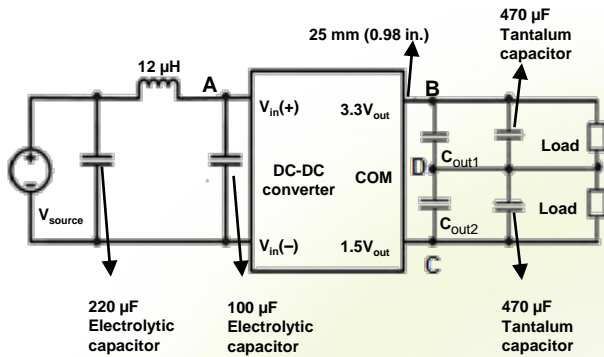

Figure 7: Test set-up diagram

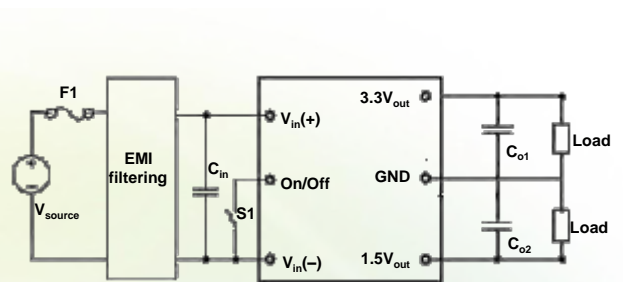

Figure 8: Typical circuit applications

F1: 5 A fuse (fast blowing)

C<sub>in</sub>: The high-frequency, low equivalent series resistance (ESR) electrolytic capacitor (100  $\mu\text{F}/100\text{ V}$ ) is recommended.

C<sub>o1</sub>: The 6.3 V/470  $\mu\text{F}$  tantalum capacitor is recommended.

C<sub>o2</sub>: The 4 V/470  $\mu\text{F}$  tantalum capacitor is recommended.

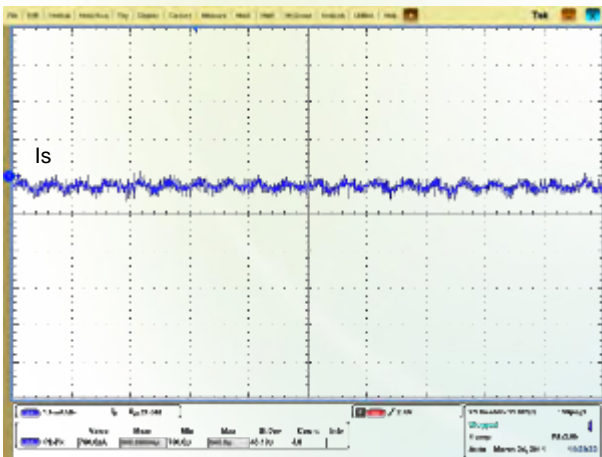

Figure 9: Input reflected ripple current  
(for point A in the test set-up diagram,  $V_{in}=48\text{ V}$ ,  
Output: 3.3 V/8 A, 1.5 V /12 A)

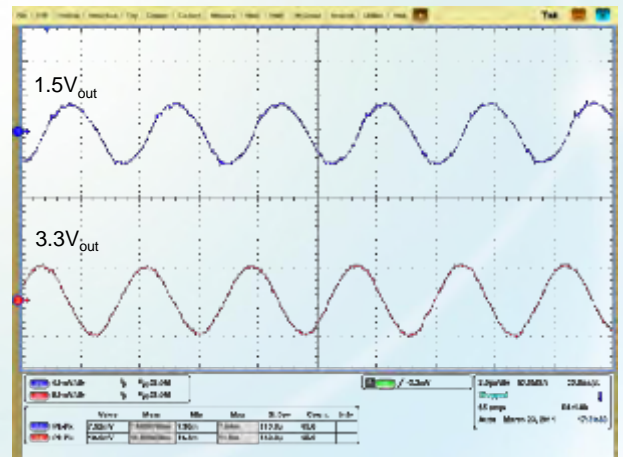

Figure 10: Output voltage ripple  
(for point BD, CD in the test set-up diagram,  
 $V_{in}=48\text{ V}$ , Output: 3.3 V/8 A, 1.5 V /12 A)

# GAQ45D3315

## DC-DC Converter Technical Manual V1.4

### Typical Waveforms

Conditions:  $T_A = 25^\circ\text{C}$  (77°F),  $V_{in} = 48\text{ V}$ .

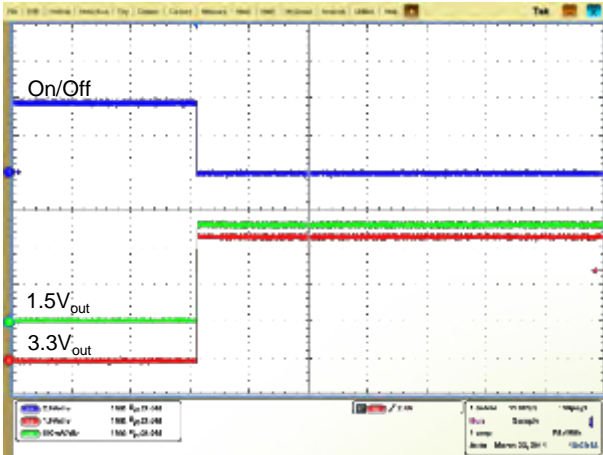

Figure 11: Startup from On/Off

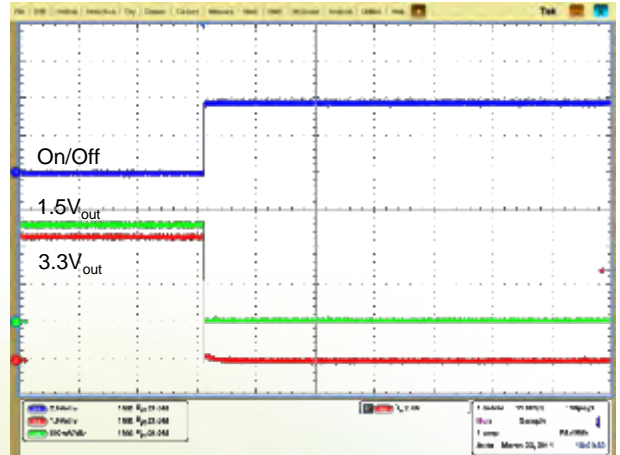

Figure 12: Shutdown from On/Off

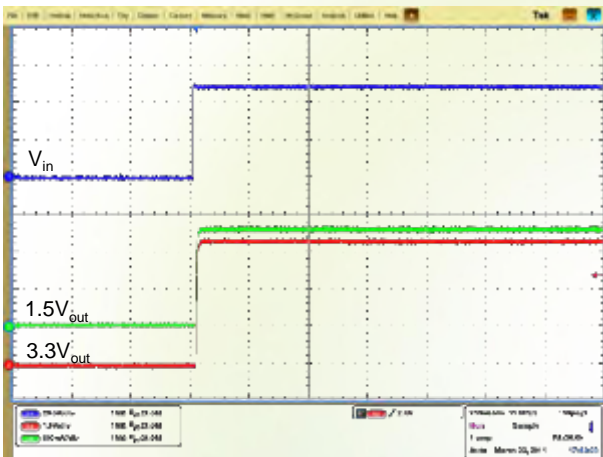

Figure 13: Startup by power on

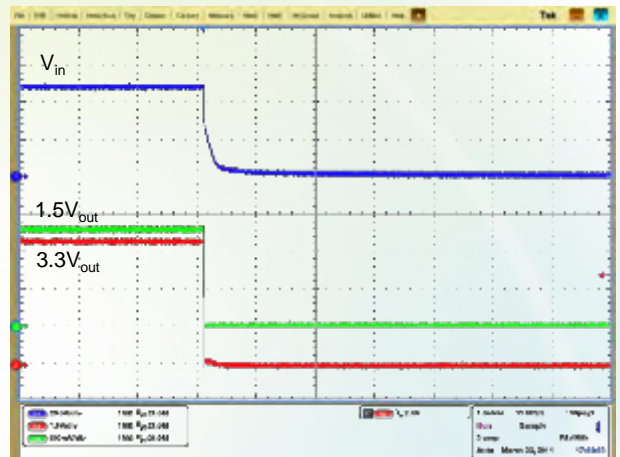

Figure 14: Shutdown by power off

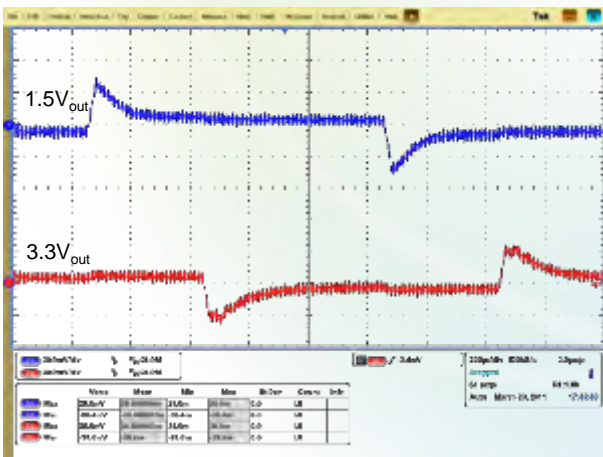

Figure 15: Output voltage dynamic response  
(Load: 25% - 50% - 25%,  $di/dt=0.1\text{ A}/\mu\text{s}$ )

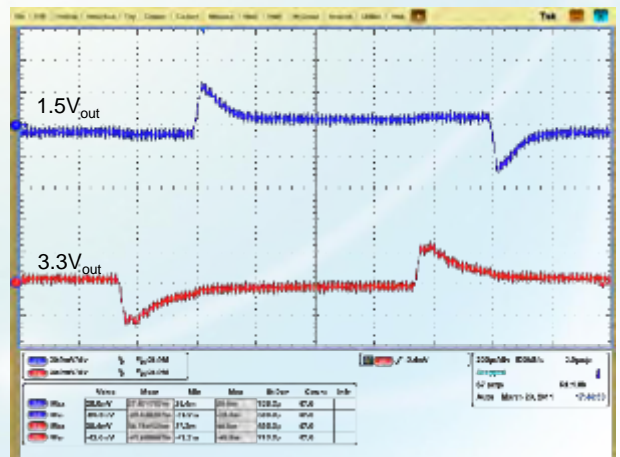

Figure 16: Output voltage dynamic response  
(Load: 50% - 75% - 50%,  $di/dt=0.1\text{ A}/\mu\text{s}$ )



# GAQ45D3315

## DC-DC Converter Technical Manual V1.4

### Remote On/Off

Logic Enable	On/Off Pin Level	Status
Negative logic	Low level	On
	High level or left open	Off

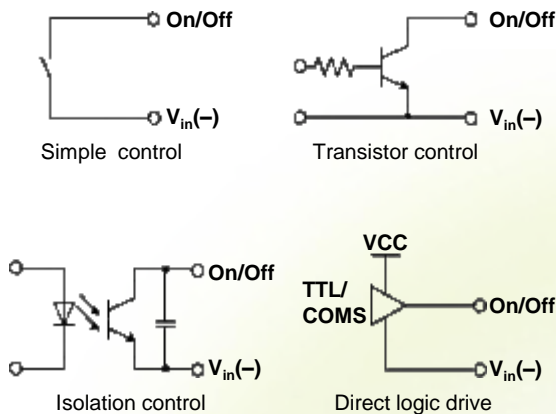

Figure 17: various circuits for driving the On/Off pin

### Output Voltage Trim

The 1.5 V output voltage can be adjusted according to the trim range specification by using the Trim pin.

#### Trim Up

The 1.5 V output voltage can be increased by installing an external resistor between the Trim pin and the 1.5V<sub>out(+)</sub> pin.

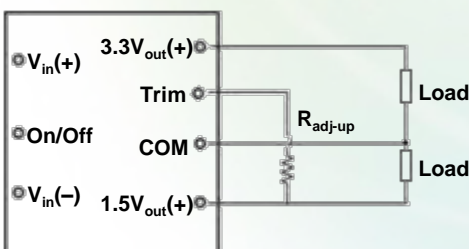

Figure 18: Configuration diagram for Trim up

The relationship between  $R_{adj-up}$  and  $V_{out}$ :

$$R_{adj-up} = \frac{5.1 \times V_{nom} \times (100 + \Delta)}{1.225 \times \Delta} - \frac{510}{\Delta} - 10.2(kohm)$$

$$\Delta = \frac{V_{trim-up} - V_{nom}}{V_{nom}} \times 100$$

#### NOTE

1. If the Trim pin is not used, it should be left open.
2. Ensure that the actual output power does not exceed the maximum output power when raising the voltage.

#### Trim Down

The 1.5 V output voltage can be decreased by installing an external resistor between the Trim pin and the COM pin.

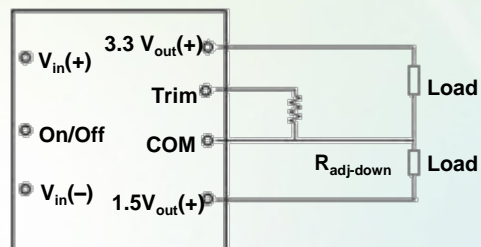

Figure 19: Configuration diagram for Trim down

The relationship between  $R_{adj-down}$  and  $V_{out}$ :

$$R_{adj-down} = \frac{510}{\Delta} - 10.2(kohm)$$

$$\Delta = \frac{V_{nom} - V_{trim-down}}{V_{nom}} \times 100$$

# GAQ45D3315

## DC-DC Converter Technical Manual V1.4

### Input Undervoltage Protection

The converter will shut down after the input voltage drops below the undervoltage protection threshold for shutdown. The converter will start to work again after the input voltage reaches the input undervoltage protection threshold for startup. For the Hysteresis, see the Protection characteristics.

### Output Overcurrent Protection

The converter equipped with current limiting circuitry can provide protection from an output overload or short circuit condition. If the output current exceeds the output overcurrent protection set point, the converter enters hiccup mode. When the fault condition is removed, the converter will automatically restart.

### Output Overvoltage Protection

When the voltage directly across the output pins exceeds the output overvoltage protection threshold, the converter will enter hiccup mode. When the fault condition is removed, the converter will automatically restart.

### Overtemperature Protection

A temperature sensor on the converter senses the average temperature of the module. It protects the converter from being damaged at high temperatures. When the temperature exceeds the overtemperature protection threshold, the output will shut down. It will allow the converter to turn on again when the temperature of the sensed location falls by the value of Overtemperature Protection Hysteresis.

### Recommended Fuse

The converter has no internal fuse. To meet safety and regulatory requirements, a 5 A fuse is recommended.



#### NOTE

The fuse current should be 1.5 to 2 times the maximum operating current in actual use.

### Recommend Reverse Polarity Protection Circuit

Reverse polarity protection is recommended under installation and cabling conditions where reverse polarity across the input may occur.

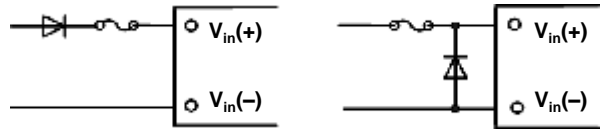

Figure 20: Recommend reverse polarity protection circuits

### MTBF

The MTBF is calculated according to the Telcordia, SR332 Method 1 Case3.

### EMC

For the acceptance standard, see the *DC-DC Converter EMC Acceptance Manual*.

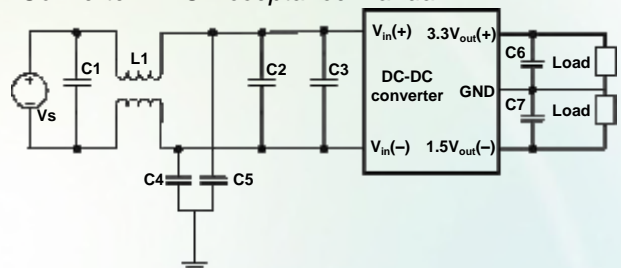

Figure 21: EMC test set-up diagram

C1: Surface mount device (SMD) ceramic capacitor (100 V/1000 nF/X7R/1210)

C2: SMD ceramic capacitor (100 V/100 nF/±10%/X7R/1206)

L1: Common-mode inductor (single phase, 1320  $\mu\text{H}$  ±25%/4 A/R5K/ 21 mm x 21 mm x 12.5 mm [0.83 in. x 0.83 in. x 0.49 in.]). The chip component with the same specifications can also be used.

C4, C5: High-pressure resistant chip ceramic capacitor (22 nF/1000 V/X7R/1210)

C3: Aluminum electrolytic capacitor (100  $\mu\text{F}$ /100 V)

C6: Tantalum capacitor(470  $\mu\text{F}$ /6.3 V)

C7: Tantalum capacitor(470  $\mu\text{F}$ /4 V)

# GAQ45D3315

## DC-DC Converter Technical Manual V1.4

### Qualification Testing

Parameter	Units	Condition
High Accelerated Life Test (HALT)	4	Lowest operating temperature: -60°C (-76°F); highest operating temperature: 100°C (212°F); vibration limit: 40 G
Proof Of Screen (POS)	4	80 temperature cycles; 50% vibration limit stress: 20 G
High Accelerated Stress Audit (HASA)	8	4 temperature cycles; 50% vibration limit stress: 20 G
Thermal Shock	32	500 temperature cycles between -40°C (-40°F) and +125°C (+257°F) with the temperature change rate of 20°C (68°F) per minute Lasting for 30 minutes both at -40°C (-40°F) and +125°C (+257°F)
Temperature Humidity Bias	16	85°C (185°F); 85% RH; 1000 operating hours under lowest load power

### Thermal Consideration

#### Thermal Test Point

Sufficient airflow should be provided to ensure reliable operating of the converter. Therefore, thermal components are mounted on the top surface of the converter to dissipate heat to the surrounding environment by conduction, convection and radiation. Proper airflow can be verified by measuring the temperature at the thermal test point.

Thermal test point



Figure 22: Thermal test point



#### NOTE

The temperature at the thermal test point on the converter cannot exceed 105°C (221°F). Otherwise, the converter will be protected against overtemperature and will not operate properly.

#### Power Dissipation

The converter power dissipation is calculated based on efficiency. The following formula reflects the relationship between the consumed power ( $P_d$ ), efficiency ( $\eta$ ), and output power ( $P_o$ ):  

$$P_d = P_o(1-\eta)/\eta$$

#### Thermal Testing Setup

Test board: D x W=254 mm x 254 mm [10 in. x 10 in.], 1oz, 4 layers.

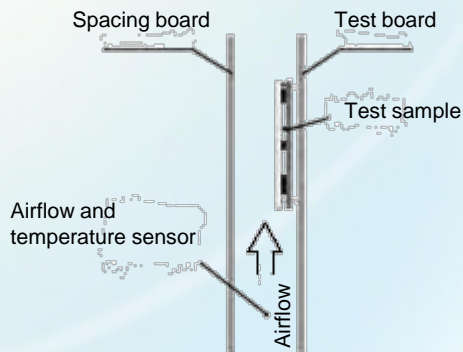

Figure 23: Wind tunnel test setup

# GAQ45D3315

## DC-DC Converter Technical Manual V1.4

### Mechanical Consideration

---

#### Installation

Although the converter can be mounted in any direction, free airflow must be taken.

#### Soldering

The converter is compatible with standard wave soldering techniques. When wave soldering, the converter pins should be preheated for 20 - 30 seconds at 110°C (230°F) , and wave soldered at 260°C (500°F) for less than 10 seconds.

When hand soldering, the iron temperature should be maintained at 425°C (797°F) and applied to the converter pins for less than 5 seconds.

The converter can be rinsed using the isopropyl alcohol (IPA) solvent or other proper solvents.

**HUAWEI TECHNOLOGIES CO., LTD.**  
Huawei Industrial Base Bantian Longgang  
Shenzhen 518129  
People's Republic of China  
[www.huawei.com](http://www.huawei.com)