

GAS08S12B

DC-DC Converter Technical Manual V1.4

Sixteenth-Brick
DC-DC Converter

36 - 75 V
Input

12 V Output

7.5 A Current

Negative
Logic

Description

The GAS08S12B is a new generation isolated DC-DC converter that uses an industry standard sixteenth-brick structure, and features high efficiency and power density, operates from an input voltage range of 36 V to 75 V, provides the rated output voltage of 12 V and the maximum output current of 7.5 A.

Operational Features

- Input voltage: 36 - 75 V
- Output current: 0 - 7.5 A
- Low output ripple and noise
- Efficiency: 93.0% (12 V, 7.5 A)

Mechanical Features

- Industry standard sixteenth-brick (D x W x H): 33.0 mm x 22.9 mm x 12.7 mm (1.30 in. x 0.90 in. x 0.50 in.)
- Weight: about 30 g

Protection Features

- Input undervoltage protection
- Output overcurrent protection (hiccup mode)
- Output short circuit protection (hiccup mode)
- Output overvoltage protection (hiccup mode)
- Overtemperature protection (self-recovery)



GAS08S12B

Control Features

- Remote on/off

Safety Features

- UL60950-1 and CSA C22.2 No. 60950-1-07
- Meet UL94V-0 flammability requirements
- RoHS6 compliant

GAS08S12B

DC-DC Converter Technical Manual V1.4

Designation Explanation

GAS 08 S 12 B
1 2 3 4 5

- 1 — 48Vin, high performance, analog control sixteenth-brick
- 2 — Output current: 7.5 A
- 3 — Single output
- 4 — Output voltage: 12 V
- 5 — With a baseplate

Mechanical Diagram

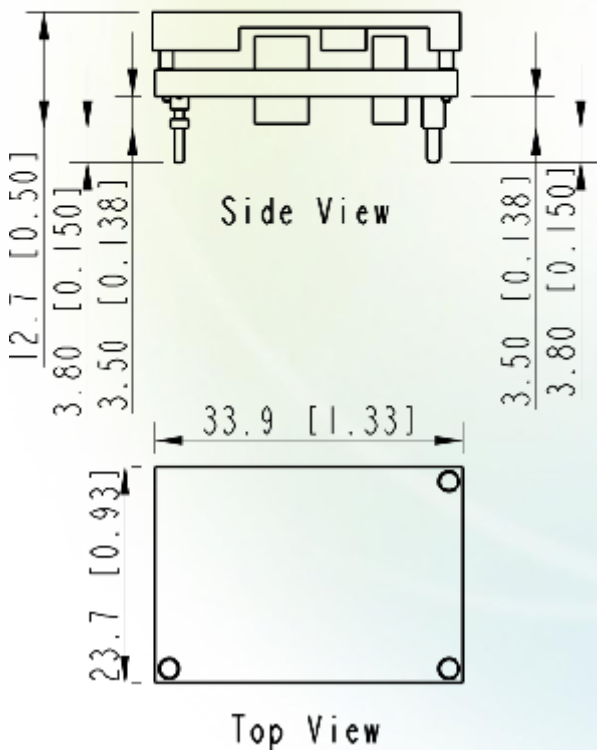
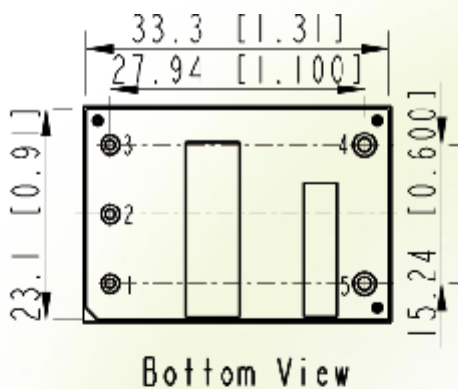

Pin Description

Pin No.	Function
1	$V_{in} (+)$
2	On/Off
3	$V_{in} (-)$
4	$V_{out} (-)$
5	$V_{out} (+)$

NOTE

1. All dimensions in mm [in.]
Tolerances: $x.x \pm 0.5$ mm [$x.xx \pm 0.02$ in.]
 $x.xx \pm 0.25$ mm [$x.xxx \pm 0.010$ in.]
2. Pin 1-3 are 1.00 ± 0.05 mm [0.040 ± 0.002 in.] diameter with 2.00 ± 0.10 mm [0.080 ± 0.004 in.] diameter standoff shoulders.
Pin4 and pin5 are 1.50 ± 0.05 mm [0.060 ± 0.002 in.] diameter with 2.50 ± 0.10 mm [0.098 ± 0.004 in.] diameter standoff shoulders.

GAS08S12B

DC-DC Converter Technical Manual V1.4

Electrical Specifications

Conditions: $T_A = 25^\circ\text{C}$ (77°F), Airflow = 1 m/s (200 LFM), $V_{in} = 48\text{ V}$, unless otherwise notes.

Parameter	Min.	Typ.	Max.	Units	Notes & Conditions
Absolute maximum ratings					
Input voltage					
Continuous	-	-	80	V	-
Transient (100 ms)	-	-	100	V	-
Operating ambient temperature	-40	-	85	°C	See the thermal derating curve
Storage temperature	-55	-	125	°C	-
Operating humidity	10	-	95	% RH	Non-condensing
Input characteristics					
Operating input voltage	36	48	75	V	-
Maximum input current	-	-	3.5	A	$V_{in} = 36\text{ V}$; $I_{out} = 7.5\text{ A}$
No-load loss	-	2.1	-	W	$V_{in} = 48\text{ V}$; $I_{out} = 0\text{ A}$
Input capacitance	100	100	-	μF	Aluminum electrolytic capacitor
Inrush transient	-	-	1	A^2s	-
Input reflected ripple current (peak to peak)	-	25	-	mA	Oscilloscope bandwidth: 20 MHz
Output characteristics					
Output voltage set point	11.8	12	12.2	V	$V_{in} = 36 - 75\text{ V}$; $I_{out} = 7.5\text{ A}$
Output power	-	-	90	W	-
Output line regulation	-	-	± 0.20	%	$V_{in} = 36 - 75\text{ V}$; $I_{out} = 7.5\text{ A}$
Output load regulation	-	-	± 0.30	%	$V_{in} = 48\text{ V}$; $I_{out} = 0 - 7.5\text{ A}$
Regulated voltage precision	-	-	± 3	%	$V_{in} = 36 - 75\text{ V}$; $I_{out} = 0 - 7.5\text{ A}$
Temperature coefficient	-	-	0.02	$\%V_{out} / ^\circ\text{C}$	$T_A = -40^\circ\text{C}$ to $+85^\circ\text{C}$ (-40°F to $+185^\circ\text{F}$)
External capacitance	220	220	1500	μF	Aluminum electrolytic capacitor
Output current	0	-	7.5	A	-
Output ripple and noise (peak to peak)	-	100	200	mV	Oscilloscope bandwidth: 20 MHz
Output voltage rise time	-	-	20	ms	The whole range of V_{in} , I_{out} and T_A
Switching frequency	-	370	-	kHz	-

GAS08S12B

DC-DC Converter Technical Manual V1.4

Electrical Specifications

Conditions: $T_A = 25^\circ\text{C}$ (77°F), Airflow = 1 m/s (200 LFM), $V_{in} = 48\text{ V}$, unless otherwise notes.

Parameter	Min.	Typ.	Max.	Units	Notes & Conditions
Protection characteristics					
Input undervoltage protection					
Startup threshold	31	35	36	V	-
Shutdown threshold	30	32	35	V	-
Hysteresis	1	2	3	V	-
Output overcurrent protection	8.25	-	13.5	A	Hiccup mode
Output short circuit protection	-	-	-	-	Hiccup mode
Output overvoltage protection	13.8	-	16.2	V	Hiccup mode
Overtemperature protection					Self-recovery
Threshold	-	120	-	$^\circ\text{C}$	The values are obtained by measuring the temperature of the hottest power component on the top surface of the convertor
Hysteresis	3	-	-	$^\circ\text{C}$	
Dynamic characteristics					
Overshoot amplitude	-	-	600	mV	Current change rate: 0.1 A/ μs
Recovery time	-	-	200	μs	load : 25% - 50% - 25%; 50% - 75% - 50%
Efficiency					
100% load	91.0	93.0	-	%	$V_{in} = 48\text{ V}$; $I_{out} = 7.5\text{ A}$; $T_A = 25^\circ\text{C}$ (77°F)
50% load	91.5	93.0	-	%	$V_{in} = 48\text{ V}$; $I_{out} = 3.75\text{ A}$; $T_A = 25^\circ\text{C}$ (77°F)
20% load	-	88.5	-	%	$V_{in} = 48\text{ V}$; $I_{out} = 1.5\text{ A}$; $T_A = 25^\circ\text{C}$ (77°F)
Isolation characteristics					
Input-to-output Isolation voltage	-	-	1500	V DC	Basic Isolation
Other characteristics					
Remote on/off voltage					
Low level	-0.7	-	1.2	V	-
High level	3.5	-	12	V	-
On/Off current					
Low level	-	-	1.0	mA	-
High level	-	-	-	μA	-
Reliability characteristics					
Mean time between failures (MTBF)	-	1.5	-	Million hours	Telcordia SR332; 80% load; Airflow = 1.5m/s (300LFM); $T_A = 40^\circ\text{C}$ (104°F)

Characteristic Curves

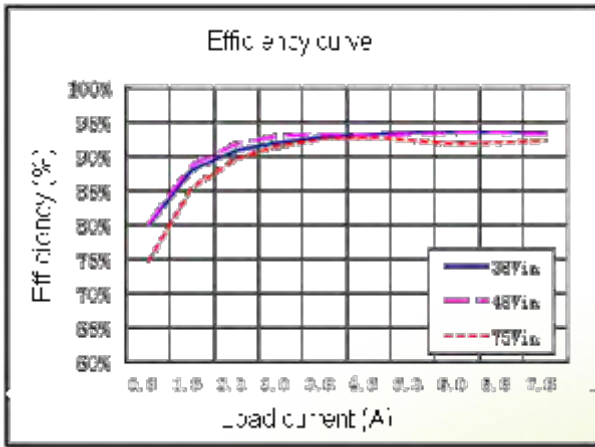

Figure 1: Efficiency ($T_A = 25^\circ\text{C}$ or 77°F)

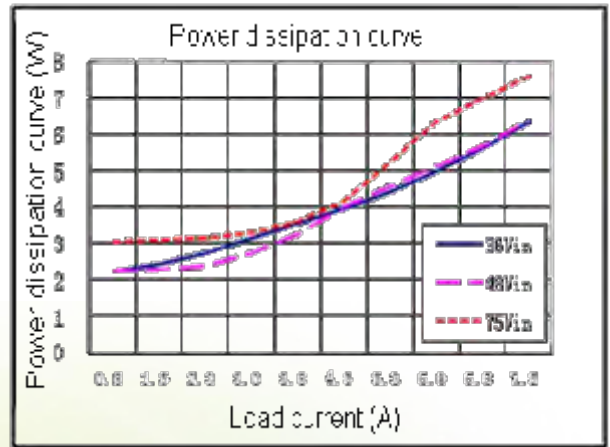

Figure 2: Power dissipation ($T_A = 25^\circ\text{C}$ or 77°F)

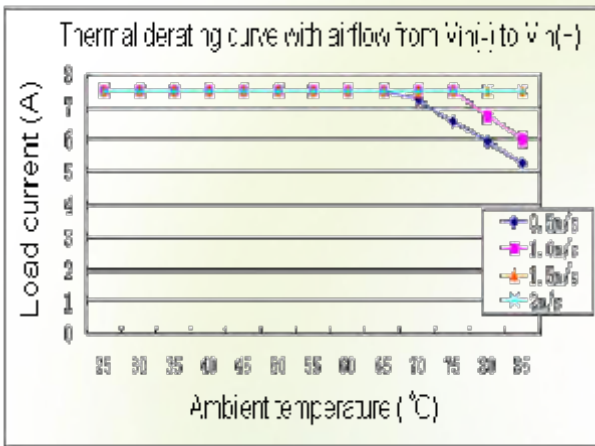

Figure 3: Thermal derating with airflow from $V_{in(-)}$ to $V_{in(+)}$ ($V_{in} = 48\text{ V}$; $V_{out} = 12\text{ V}$)

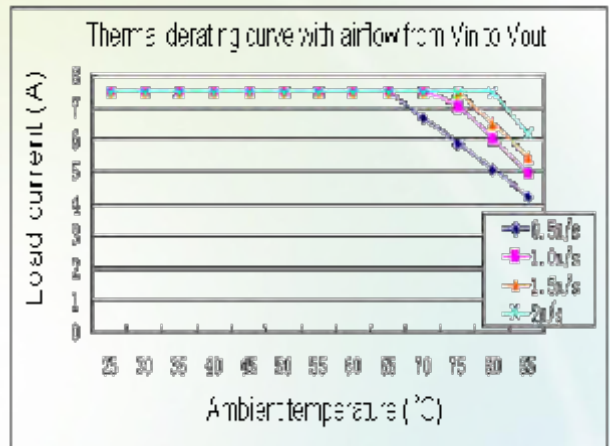

Figure 4: Thermal derating with airflow from $V_{in(-)}$ to $V_{in(+)}$ ($V_{in} = 48\text{ V}$; $V_{out} = 12\text{ V}$)

GAS08S12B

DC-DC Converter Technical Manual V1.4

Typical Waveforms



NOTE

1. During the test of input reflected ripple current, the input terminal must be connected to a 12 μH inductor and a 220 μF electrolytic capacitor.
2. Point B, which is for testing the output voltage ripple, is 25 mm (0.98 in.) away from the $V_{\text{out}(+)}$ pin.

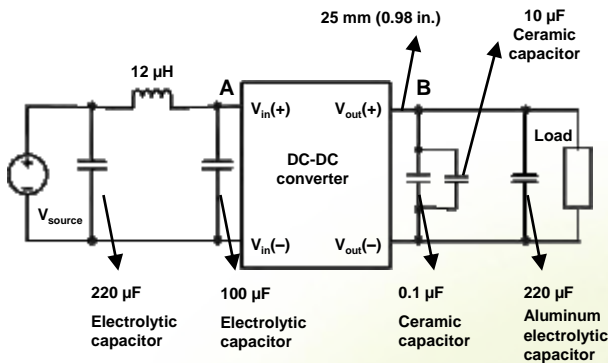

Figure 5: Test set-up diagram

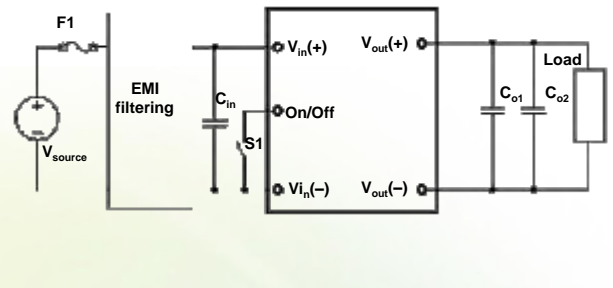

Figure 6: Typical circuit applications

F1: 10 A fuse (fast blowing)

C_{in} : The high-frequency, low equivalent series resistance (ESR) aluminum electrolytic capacitor (100 $\mu\text{F}/100\text{ V}$) is recommended.

C_{o1} : The 1 μF ceramic capacitor is recommended.

C_{o2} : The 220 μF aluminum electrolytic capacitor is recommended.

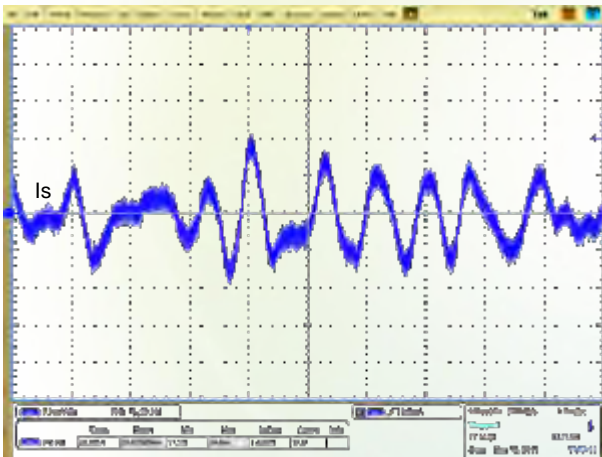

Figure 7: Input reflected ripple current (for point A in the test set-up diagram, $V_{\text{in}} = 48\text{ V}$, $V_{\text{out}} = 12\text{ V}$, $I_{\text{out}} = 7.5\text{ A}$)

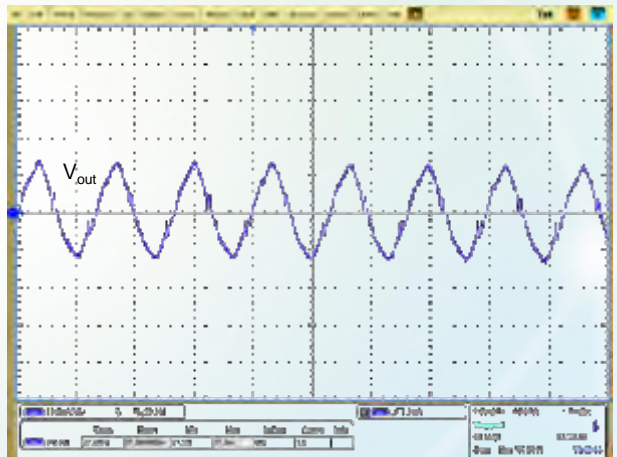

Figure 8: Output voltage ripple (for point B in the test set-up diagram, $V_{\text{in}} = 48\text{ V}$, $V_{\text{out}} = 12\text{ V}$, $I_{\text{out}} = 7.5\text{ A}$)

GAS08S12B

DC-DC Converter Technical Manual V1.4

Typical Waveforms

Conditions: $T_A = 25^\circ\text{C}$ (77°F), $V_{in} = 48\text{ V}$.

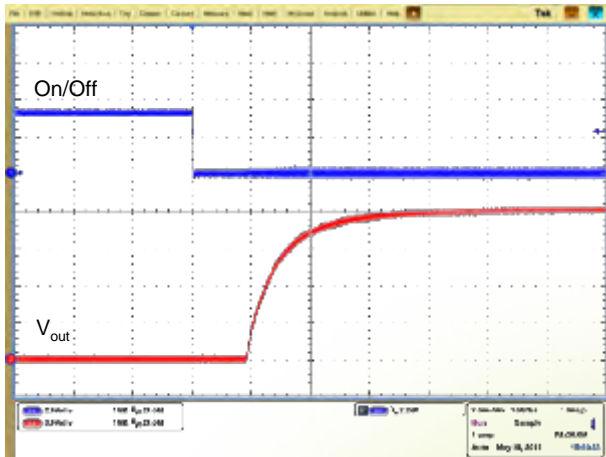

Figure 9: Startup from On/Off

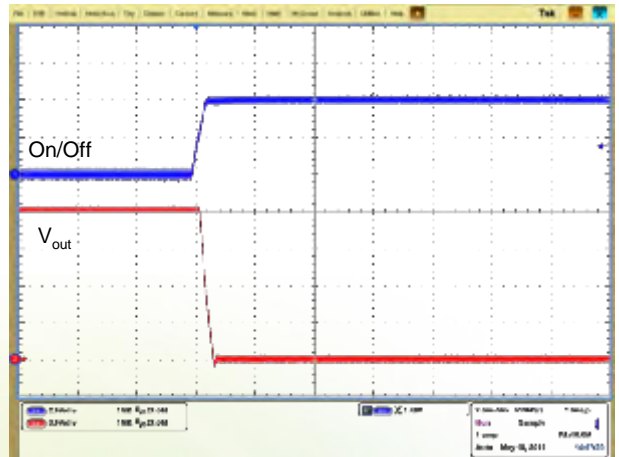

Figure 10: Shutdown from On/Off

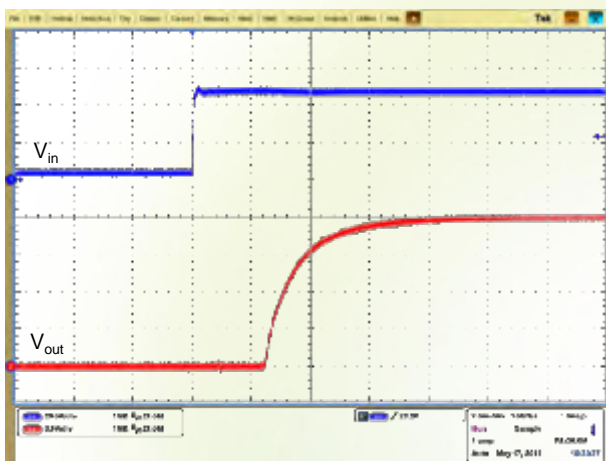

Figure 11: Startup by power on

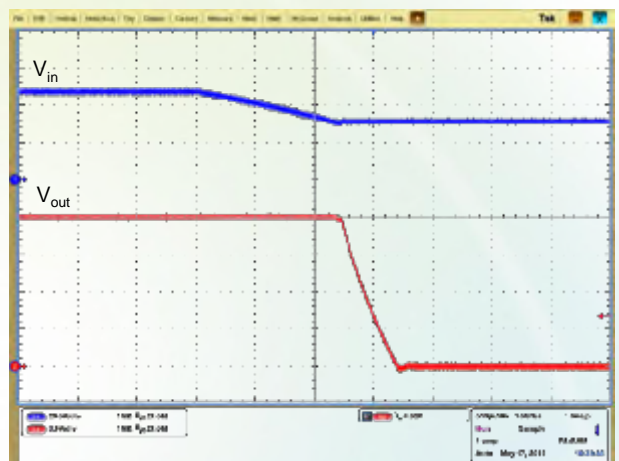

Figure 12: Shutdown by power off

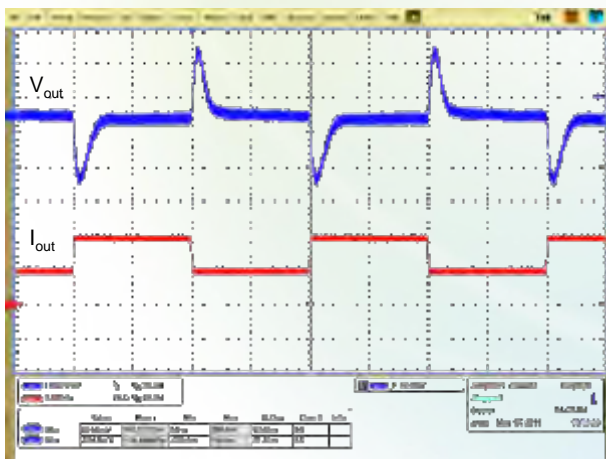

Figure 13: Output voltage dynamic response
(Load: 25% - 50% - 25%, $di/dt=0.1\text{ A}/\mu\text{s}$)

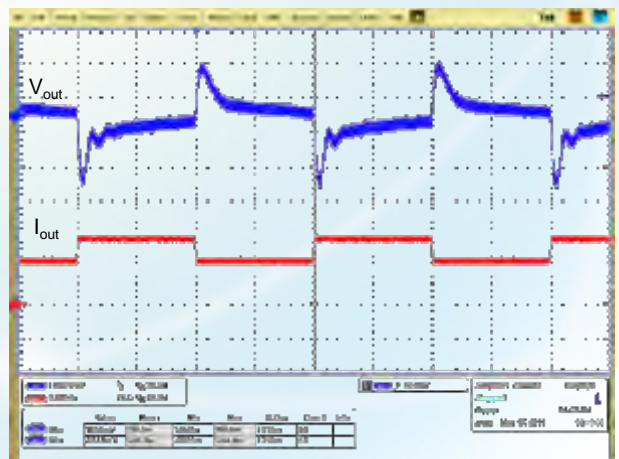

Figure 14: Output voltage dynamic response
(Load: 50% - 75% - 50%, $di/dt=0.1\text{ A}/\mu\text{s}$)

Remote On/Off

Logic Enable	On/Off Pin Level	Status
Negative logic	Low level	On
	High level or left open	Off

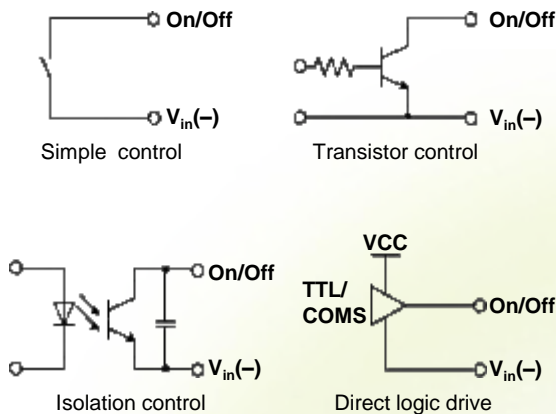

Figure 15: various circuits for driving the On/Off pin

Input Undervoltage Protection

The converter will shut down after the input voltage drops below the undervoltage protection threshold for shutdown. The converter will start to work again after the input voltage reaches the input undervoltage protection threshold for startup. For the Hysteresis, see the Protection characteristics.

Output Overcurrent Protection

The converter equipped with current limiting circuitry can provide protection from an output overload or short circuit condition. If the output current exceeds the output overcurrent protection set point, the converter enters hiccup mode. When the fault condition is removed, the converter will automatically restart.

Output Overvoltage Protection

When the voltage directly across the output pins exceeds the output overvoltage protection threshold, the converter will enter hiccup mode. When the fault condition is removed, the converter will automatically restart.

Overtemperature Protection

A temperature sensor on the converter senses the average temperature of the module. It protects the converter from being damaged at high temperatures. When the temperature exceeds the overtemperature protection threshold, the output will shut down. It will allow the converter to turn on again when the temperature of the sensed location falls by the value of Overtemperature Protection Hysteresis.

MTBF

The MTBF is calculated according to the Telcordia, SR332 Method 1 Case3.

GAS08S12B

DC-DC Converter Technical Manual V1.4

Recommend Reverse Polarity Protection Circuit

Reverse polarity protection is recommended under installation and cabling conditions where reverse polarity across the input may occur.

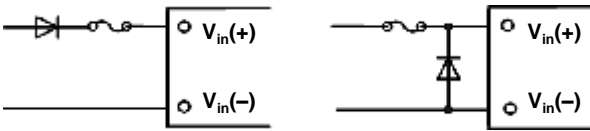

Figure 16: Recommend reverse polarity protection circuits

Recommended Fuse

The converter has no internal fuse. To meet safety and regulatory requirements, a 10 A fuse is recommended.

NOTE

The fuse current should be 1.5 to 2 times the maximum operating current in actual use.

EMC

For the acceptance standard, see the *DC-DC Converter EMC Acceptance Manual*.

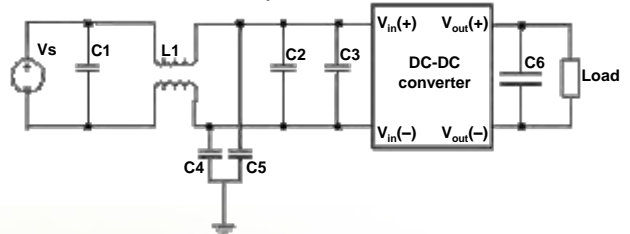

Figure 17: EMC test set-up diagram

C1: Surface mount device (SMD) ceramic capacitor (100 V/1000 nF/X7R/1210)

C2: SMD ceramic capacitor (100 V/100 nF/±10%/X7R/1206)

L1: Common-mode inductor (single phase, 1320 μH/±25%/9.7 A/R5K/ 21 mm x 21 mm x 12.5 mm [0.83 in. x 0.83 in. x 0.49 in.]). The chip component with the same specifications can also be used.

C4, C5: High-pressure resistant chip ceramic capacitor (22 nF/1000 V/X7R/1210)

C3: Aluminum electrolytic capacitor (100 μF/100 V)

C6: Aluminum electrolytic capacitor (220 μF/25 V)

Qualification Testing

Parameter	Units	Condition
High Accelerated Life Test (HALT)	4	Lowest operating temperature: -60°C (-76°F); highest operating temperature: 120°C (248°F); vibration limit: 40 G
Proof of Screen (POS)	4	80 temperature cycles; 50% vibration limit stress: 20 G
High Accelerated Stress Audit (HASA)	16	4 temperature cycles; 50% vibration limit stress: 20 G
Thermal Shock	16	500 temperature cycles between -40°C (-40°F) and +125°C (+257°F) with the temperature change rate of 20°C (68°F) per minute Lasting for 30 minutes both at -40°C (-40°F) and +125°C (+257°F)
Temperature Humidity Bias	8	85°C (185°F); 85% RH; 1000 operating hours under lowest load power
High Temperature Operation Life (HTOL)	8	Rated input voltage; ambient temperature between -40°C (-40°F) and -60°C (-76°F); 1000 operating hours under 80% load power

GAS08S12B

DC-DC Converter Technical Manual V1.4

Thermal Consideration

Thermal Test Point

Sufficient airflow should be provided to ensure reliable operating of the converter. Therefore, thermal components are mounted on the top surface of the converter to dissipate heat to the surrounding environment by conduction, convection and radiation. Proper airflow can be verified by measuring the temperature at the thermal test point.

Middle of the base plate



Figure 18: Thermal test point



NOTE

The temperature at the thermal test point on the converter cannot exceed 105°C (221°F). Otherwise, the converter will be protected against overtemperature and will not operate properly.

Power Dissipation

The converter power dissipation is calculated based on efficiency. The following formula reflects the relationship between the consumed power (P_d), efficiency (η), and output power (P_o):
$$P_d = P_o(1-\eta)/\eta$$

Thermal Testing Setup

Test board: D x W=254 mm x 254 mm [10 in. x 10 in.], 1oz, 4 layers.

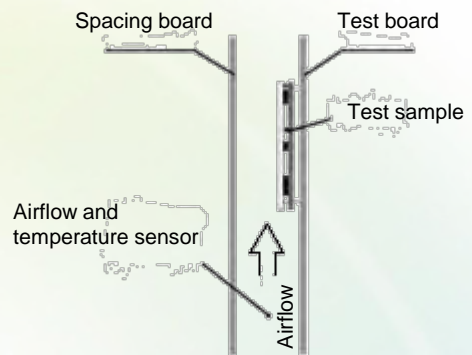

Figure 19: Wind tunnel test setup

Mechanical Consideration

Installation

Although the converter can be mounted in any direction, free airflow must be taken.

Soldering

The converter is compatible with standard wave soldering techniques. When wave soldering, the converter pins should be preheated for 20 - 30 seconds at 110°C (230°F), and wave soldered at 260°C (500°F) for less than 10 seconds.

When hand soldering, the iron temperature should be maintained at 425°C (797°F) and applied to the converter pins for less than 5 seconds.

The converter can be rinsed using the isopropyl alcohol (IPA) solvent or other proper solvents.

HUAWEI TECHNOLOGIES CO., LTD.

Huawei Industrial Base Bantian Longgang
Shenzhen 518129
People's Republic of China
www.huawei.com