

GDE20S12B/P

DC-DC Converter Technical Manual V1.4

**Eighth-Brick
DC-DC Converter**

**36 - 75 V
Input**

12 V Output

20 A Current

**Negative
Logic**

Description

The GDE20S12B/P is an isolated DC-DC converter that uses an industry nonstandard eighth-brick structure and features high efficiency and power density. It is compatible with industry standard eighth-brick. It provides 12 V outputs and supports the maximum output current of 20 A. Two GDE20S12B/Ps can be connected in parallel to provide the maximum output current of 30 A. The GDE20S12B/P communicates over PMBus 1.1 to support monitoring and alarm reporting functions, such as monitoring the output voltage and current, input voltage, digitally adjusting the voltage, and activating software.



GDE20S12B/P

Operational Features

- Input voltage: 36 - 75 V
- Output current: 0 - 20 A
- Rated output voltage: 12 V
- Efficiency: 95.0% (12 V, 20 A)

Mechanical Features

- Industry nonstandard eighth-brick (D x W x H, with a baseplate): 58.4 mm x 22.8 mm x 12.7 mm (2.30 in. x 0.90 in. x 0.50 in.)
- Weight: about 40 g

Protection Features

- Input undervoltage protection
- Output overcurrent protection (hiccup mode)
- Output short circuit protection (hiccup mode)
- Output overvoltage protection (hiccup mode)
- Overtemperature protection (self-recovery)

Key Features

- PMBus Revision 1.1 compliant

Monitoring Features

- Activates hardware and software
- Digitally adjusts the voltage
- Monitors the input and output voltages
- Monitors the output current
- Monitors the converter temperature

Safety Features

- UL60950-1 and CSA C22.2 No. 60950-1-07
- Meet UL94V-0 flammability requirements
- RoHS6 compliant

GDE20S12B/P

DC-DC Converter Technical Manual V1.4

Designation Explanation

GDE 20 S 12 B /P
 1 2 3 4 5 6

- 1 — 48Vin, high performance, digital control quarter-brick
- 2 — Output current: 20 A
- 3 — Single output
- 4 — Output voltage: 12 V
- 5 — With a baseplate
- 6 — With a PMBus port

Mechanical Diagram

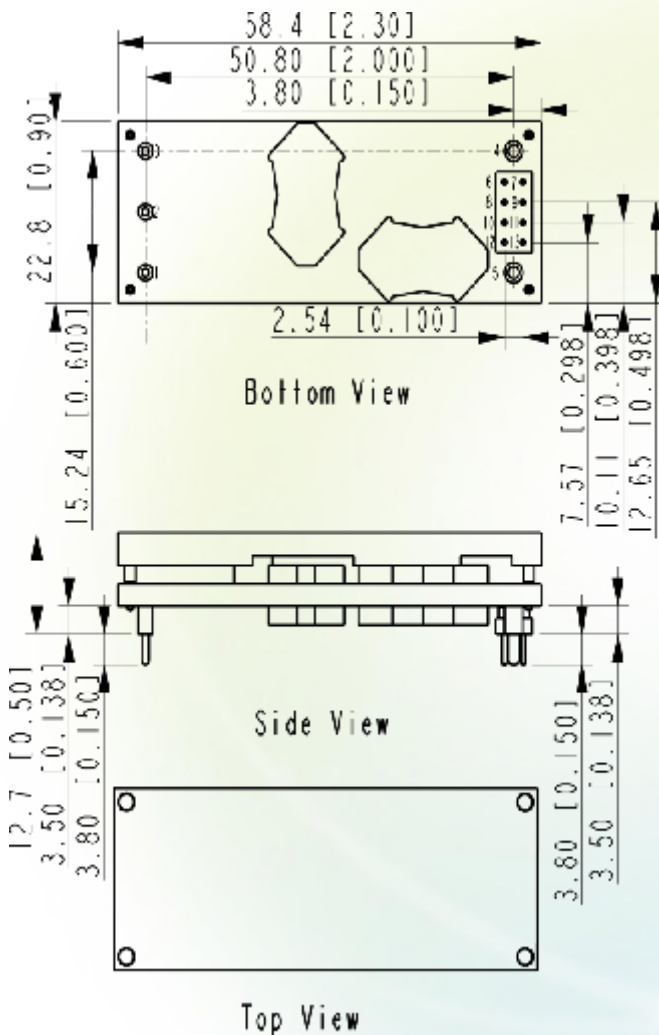

Pin Description

Pin No.	Function
1	V _{in} (+)
2	On/Off
3	V _{in} (-)
4	V _{out} (-)
5	V _{out} (+)
6	SGND
7	SA0
8	PMBus_ALT
9	SA1
10	PMBus_CTL
11	ISHARE
12	PMBus_SCL
13	PMBus_SDA

NOTE

- All dimensions in mm [in.]
 Tolerances: x.x ± 0.5 mm [x.xx ± 0.02 in.]
 x.xx ± 0.25 mm [x.xxx ± 0.010 in.]
- Pin 1-3 are 1.00 ± 0.05 mm [0.040 ± 0.002 in.] diameter with 2.00 ± 0.10 mm [0.080 ± 0.004 in.] diameter standoff shoulders.
 Pin4 and pin5 are 1.50 ± 0.05 mm [0.060 ± 0.002 in.] diameter with 2.50 ± 0.10 mm [0.098 ± 0.004 in.] diameter standoff shoulders.
 Pin6 -13 are 0.64 ± 0.05 mm [0.025 ± 0.002 in.] diameter.

GDE20S12B/P

DC-DC Converter Technical Manual V1.4

Electrical Specifications

Conditions: $T_A = 25^\circ\text{C}$ (77°F), Airflow = 1 m/s (200 LFM), $V_{in} = 48\text{ V}$, unless otherwise notes.

Parameter	Min.	Typ.	Max.	Units	Notes & Conditions
Absolute maximum ratings					
Input voltage					
Continuous	-	-	80	V	-
Transient (100 ms)	-	-	100	V	-
Operating ambient temperature	-40	-	85	°C	See the thermal derating curve
Storage temperature	-55	-	125	°C	-
Operating humidity	-	-	95	% RH	Non-condensing
Input characteristics					
Operating input voltage	36	48	75	V	-
Maximum input current	-	-	10	A	$V_{in} = 36 - 75\text{ V}$; $I_{out} = 20\text{ A}$
No-load loss	-	9.6	-	W	$V_{in} = 36 - 75\text{ V}$; $I_{out} = 0\text{ A}$
Input capacitance	100	220	-	μF	Electrolytic capacitor
Inrush transient	-	-	1	A ² s	-
Input reflected ripple current (peak to peak)	-	-	100	mA	Oscilloscope bandwidth: 20 MHz
Output characteristics					
Output voltage set point	11.88	12	12.12	V	$V_{in} = 48\text{ V}$; $I_{out} = 10\text{ A}$
Output power	0	-	240	W	$V_{in} = 48\text{ V}$
Output line regulation	-	-	±0.20	%	$V_{in} = 40 - 75\text{ V}$; $I_{out} = 20\text{ A}$
	-	-	±10	%	$V_{in} = 36 - 40\text{ V}$; $I_{out} = 20\text{ A}$
Output load regulation	-	-	±3	%	$V_{in} = 48\text{ V}$; $I_{out} = 0 - 20\text{ A}$
Output voltage range	11.64	-	12.36	V	$V_{in} = 40 - 75\text{ V}$; Adjust the voltage by PMBus
	10.80	-	12.36	V	$V_{in} = 36 - 40\text{ V}$; Adjust the voltage by PMBus
Temperature coefficient	-0.02	-	0.02	% V_{out} / °C	$T_A = -40^\circ\text{C}$ to $+85^\circ\text{C}$ (-40°F to $+185^\circ\text{F}$)
External capacitance	440	-	10^4	μF	Electrolytic capacitor ($10\text{m}\Omega < \text{ESR} < 1\Omega$)
Output current	0	-	20	A	-
Output ripple and noise (peak to peak)	-	200	250	mV	Oscilloscope bandwidth: 20 MHz
Output voltage adjustment range	70	-	110	%	$V_{in} = 45 - 75\text{ V}$;
	70	-	-	%	$V_{in} = 36 - 45\text{ V}$
Output voltage overshoot	-	-	5	%	The whole range of V_{in} , I_{out} and T_A

GDE20S12B/P

DC-DC Converter Technical Manual V1.4

Electrical Specifications

Conditions: $T_A = 25^\circ\text{C}$ (77°F), Airflow = 1 m/s (200 LFM), $V_{in} = 48\text{ V}$, unless otherwise notes.

Parameter	Min.	Typ.	Max.	Units	Notes & Conditions
Output characteristics					
Output voltage rise time	-	50	100	ms	$0 - V_{out}$
Output voltage delay time	-	50	100	ms	$V_{in} - 10\%V_{out}$
Switching frequency	-	180	-	kHz	-
Protection characteristics					
Input undervoltage protection					
Startup threshold	31	34.5	35.5	V	-
Shutdown threshold	30	32.5	35	V	-
Hysteresis	1	-	4	V	-
Output overcurrent protection	22	25	28	A	Hiccup mode; $V_{in} = 36 - 75\text{ V}$
Output short circuit protection	-	-	5	Arms	Hiccup mode
Output overvoltage protection	14	15	16	V	Hiccup mode
Overtemperature protection					Self-recovery. The values are obtained by measuring the temperature of the hottest power component on the top surface of the converter
Threshold	-	130	-	$^\circ\text{C}$	
Hysteresis	10	15	20	$^\circ\text{C}$	
Dynamic characteristics					
Overshoot amplitude	-	-	600	mV	Current change rate: 0.1 A/ μs load : 25% - 50% - 25%
Recovery time	-	-	200	μs	
Overshoot amplitude	-	-	600	mV	Current change rate: 0.1 A/ μs load : 50% - 75% - 50%
Recovery time	-	-	300	μs	
Efficiency					
100% load	94.5	95.0	-	%	$V_{in} = 48\text{ V}$; $I_{out} = 20\text{ A}$; $T_A = 25^\circ\text{C}$ (77°F)
50% load	94.0	94.5	-	%	$V_{in} = 48\text{ V}$; $I_{out} = 10\text{ A}$; $T_A = 25^\circ\text{C}$ (77°F)
30% load	91.5	92.0	-	%	$V_{in} = 48\text{ V}$; $I_{out} = 6\text{ A}$; $T_A = 25^\circ\text{C}$ (77°F)
Isolation characteristics					
Input-to-output Isolation voltage	-	-	1500	V DC	Functional Isolation
Reliability characteristics					
Mean time between failures (MTBF)	-	1.5	-	Million hours	Telcordia SR332; 80% load; Airflow = 1.5 m/s (300 FLM); $T_A = 40^\circ\text{C}$ (104°F)
Parallel characteristics					
Maximum parallel output voltage	0	-	360	W	$V_{in} = 36 - 75\text{ V}$

GDE20S12B/P

DC-DC Converter Technical Manual V1.4

Electrical Specifications

Conditions: $T_A = 25^\circ\text{C}$ (77°F), Airflow = 1 m/s (200 LFM), $V_{in} = 48\text{ V}$, unless otherwise notes.

Parameter	Min.	Typ.	Max.	Units	Notes & Conditions
Parallel characteristics					
Unbalance of current equalization	-	-	10	%	$V_{in} \geq 38\text{ V}$, $P_{out} \geq 200\text{ W}$
Input capacitance	200	-	-	μF	-
Output external capacitance	880	-	10^4	μF	-
Maximum parallel start load	-	-	20	A	$V_{in} = 36 - 75\text{ V}$
Maximum output power delay time	2	-	-	S	$V_{in} = 36 - 75\text{ V}$
Current equalization adjustment	-	-	0.8	V	$V_{in} = 40 - 75\text{ V}$; $P_{out} = 200 - 360\text{ W}$ (Trim up & Trim down); For the value under condition 36 - 40 V, see practice test result
Output ripple and noise		300	500	mV	$V_{in} = 36 - 75\text{ V}$; $P_{out} = 0 - 360\text{ W}$; Oscilloscope bandwidth: 20 MHz
Logic input and output pins in the communications port characteristics					
Logic input low level	-	-	1.1	V	-
Logic input high level	2.1	-	3.6	V	-
Logic output low level	-	0.25	-	V	$I_{OL} = 6\text{ mA}$
Logic output high level	2.7	-	3.6	V	$I_{OH} = -6\text{ mA}$
PMBus setting-up time	100	-	-	ns	For details about the values of t_{set} and t_{hold} , see "Definition of I2C/PMBus Setting-up Time and Holding Time"
PMBus holding time	0	-	-	ns	
Other characteristics					
Primary On/Off voltage					
Low level	0.7	-	1.2	V	The low electric level is effective
High level	2.8	-	8	V	
Primary On/Off current					
Low level	-	-	1	mA	-
Secondary CTL voltage					
Low level	0	-	0.8	V	The high electric level is effective
High level	-	3.3	3.6	V	
PMBus detected precision					
Input voltage detected precision	-1	-	1	V	$V_{in} = 36 - 75\text{ V}$; $I_{out} = 0 - 20\text{ A}$; $T_A = -40^\circ\text{C}$ (-40°F) to $+85^\circ\text{C}$ (+185°F)
Output voltage detected precision	0.2	-	0.2	V	
Output current detected precision	-1	-	1	A	
Temperature detected precision	-5		5	$^\circ\text{C}$	

GDE20S12B/P

DC-DC Converter Technical Manual V1.4

Characteristic Curves

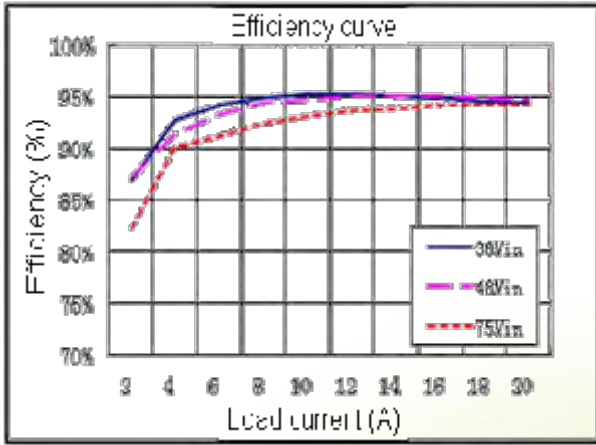

Figure 1: Efficiency ($T_A = 25^\circ\text{C}$ or 77°F)

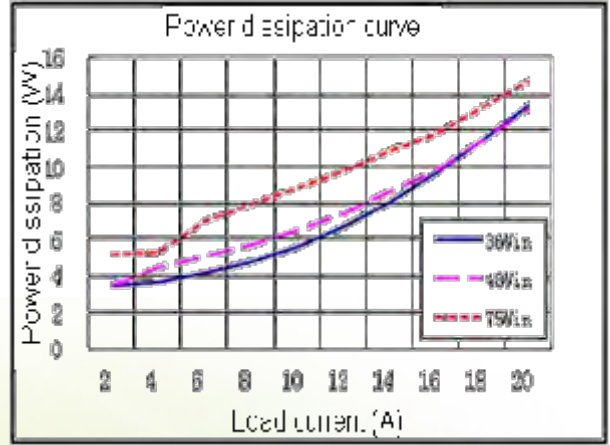

Figure 2: Power dissipation ($T_A = 25^\circ\text{C}$ or 77°F)

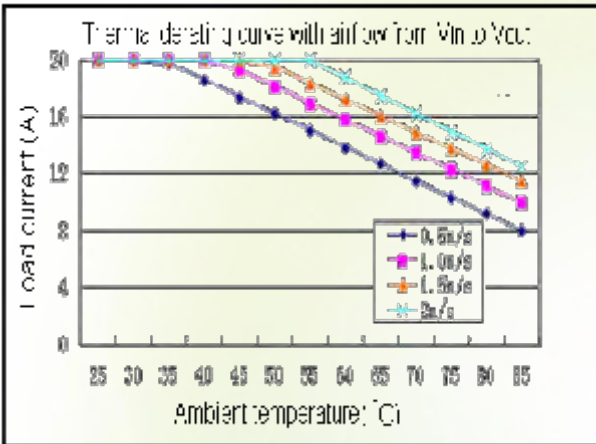

Figure 3: Thermal derating with airflow from $V_{in(-)}$ to V_{out} ($V_{in} = 48\text{ V}$; $V_{out} = 12\text{ V}$)

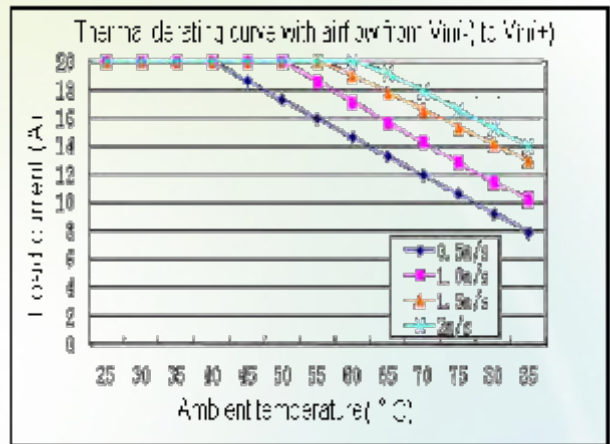

Figure 4: Thermal derating with airflow from $V_{in(-)}$ to $V_{in(+)}$ ($V_{in} = 48\text{ V}$; $V_{out} = 12\text{ V}$)

GDE20S12B/P

DC-DC Converter Technical Manual V1.4

Typical Waveforms



NOTE

1. During the test of input reflected ripple current, the input terminal must be connected to a 12 μH inductor and a 220 μF electrolytic capacitor.
2. Point B, which is for testing the output voltage ripple, is 25 mm (0.98 in.) away from the $V_{\text{out}(+)}$ pin.

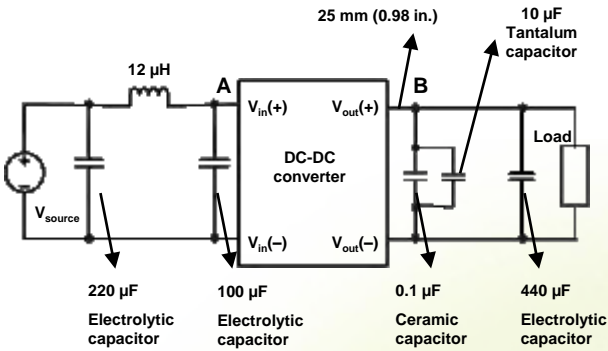

Figure 5: Test set-up diagram

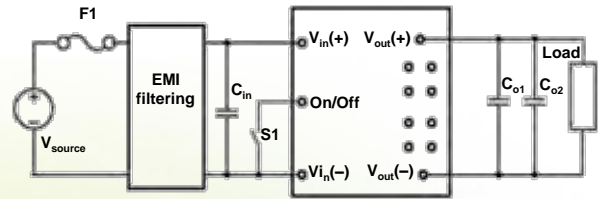

Figure 6: Typical circuit applications

F1: 30 A fuse (fast blowing)

C_{in} : The high-frequency, low equivalent series resistance (ESR) electrolytic capacitor (100 $\mu\text{F}/100\text{ V}$) is recommended.

C_{01} : The 1 $\mu\text{F}/25\text{ V}$ ceramic capacitor is recommended.

C_{02} : The 440 μF electrolytic capacitor is recommended.

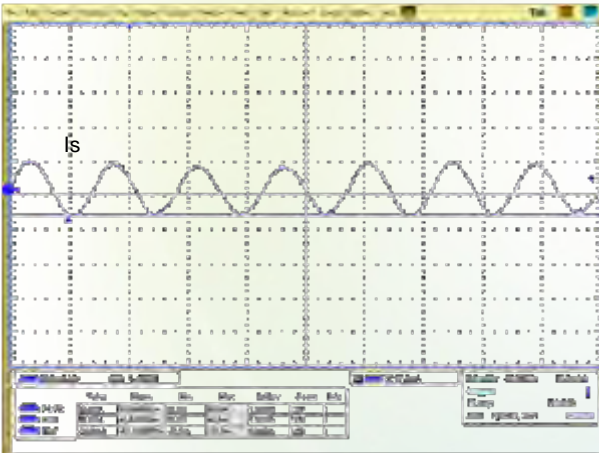

Figure 7: Input reflected ripple current (for point A in the test set-up diagram, $V_{\text{in}} = 48\text{ V}$, $V_{\text{out}} = 12\text{ V}$, $I_{\text{out}} = 20\text{ A}$)

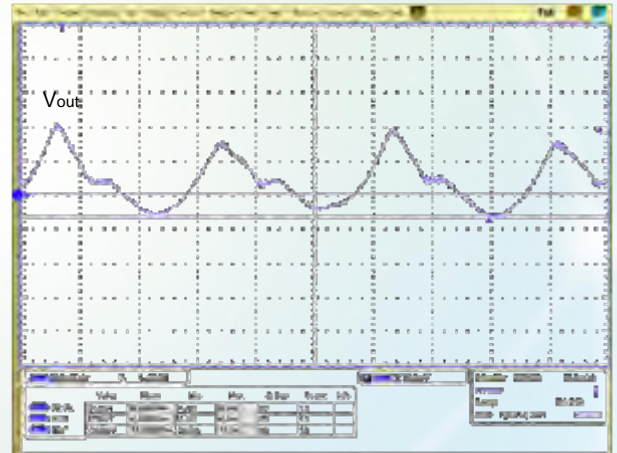

Figure 8: Output voltage ripple (for point B in the test set-up diagram, $V_{\text{in}} = 48\text{ V}$, $V_{\text{out}} = 12\text{ V}$, $I_{\text{out}} = 20\text{ A}$)

GDE20S12B/P

DC-DC Converter Technical Manual V1.4

Typical Waveforms

Conditions: $T_A = 25^\circ\text{C}$ (77°F), $V_{in} = 48\text{ V}$.

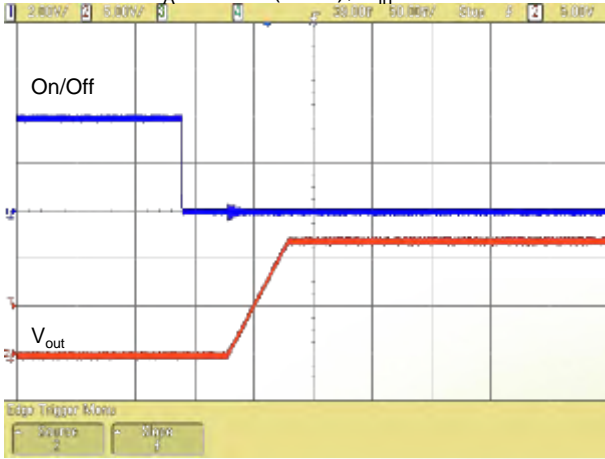

Figure 9: Startup from On/Off

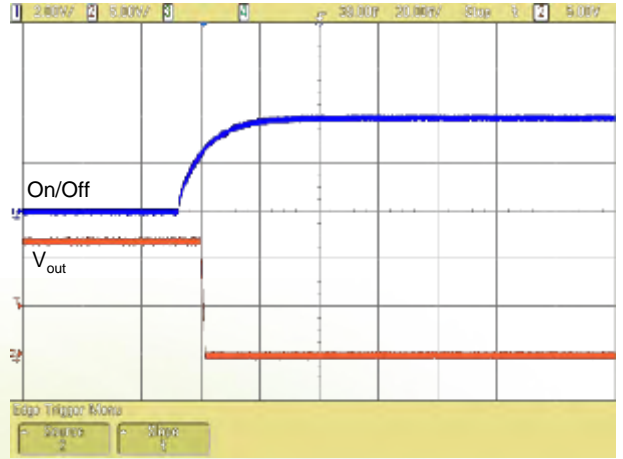

Figure 10: Shutdown from On/Off

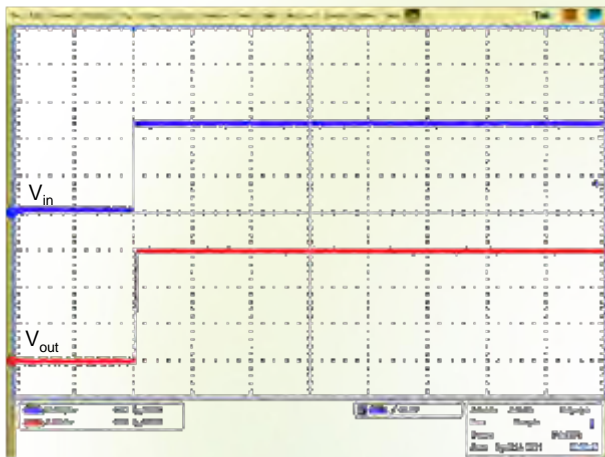

Figure 11: Startup by power on

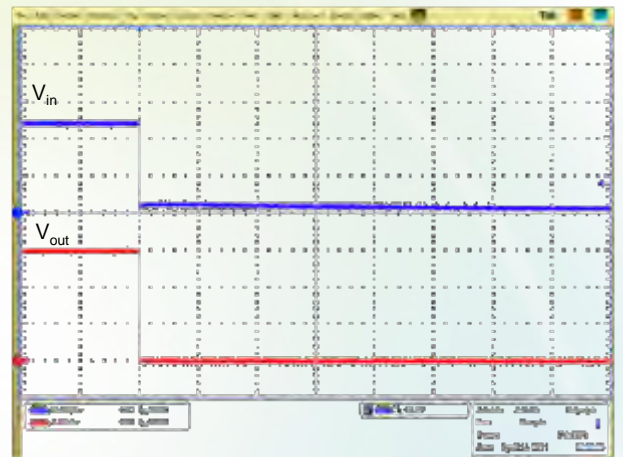

Figure 12: Shutdown by power off

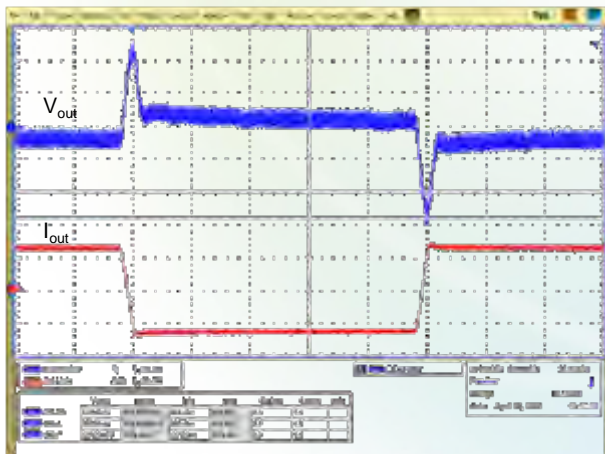

Figure 13: Output voltage dynamic response
(Load : 25% - 50% - 25%, $di/dt=0.1\text{ A}/\mu\text{s}$)

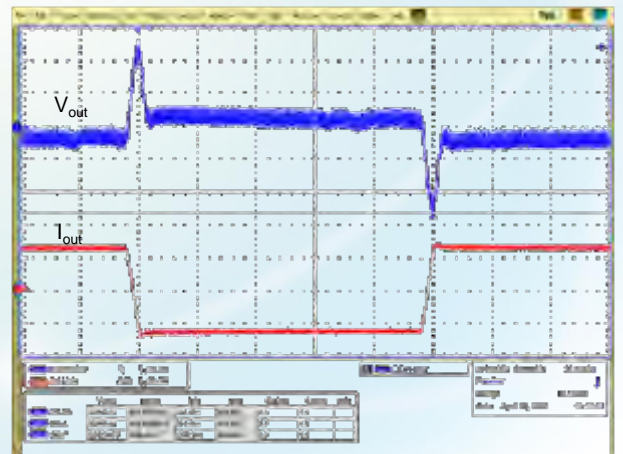

Figure 14: Output voltage dynamic response
(Load : 50% - 75% - 50%, $di/dt=0.1\text{ A}/\mu\text{s}$)

GDE20S12B/P

DC-DC Converter Technical Manual V1.4

Remote On/Off

Logic Enable	On/Off Pin Level	Status
Negative logic	Low level	On
	High level or left open	Off

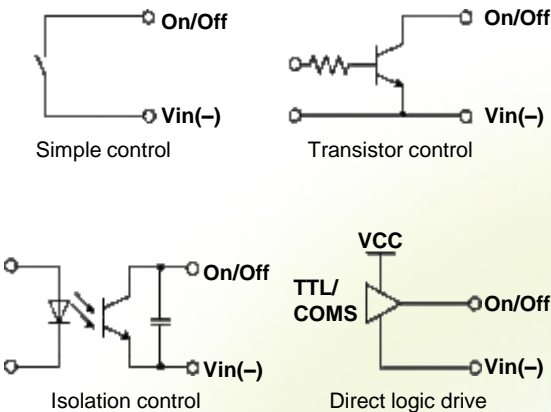

Figure 15: Various circuits for driving the On/Off pin

CTL Secondary Enable Control

When the On/Off is in low electric level, the PMBus_CTL can perform secondary enable control.

PMBus CTL Pin Level	Status
Low level	No output
High level or left open	Have output

Output Voltage Adjust using PMBus

The converter supports online voltage adjustment by PMBus commands. The output voltage can be adjusted within the range of 8.4 V to 13.2 V ($V_{in}=45 - 75$ V).

Software Secondary Enable Control

See the PMBus communications protocol.

Soft-start Power Up

The default output voltage delay time ($V_{in} - 10\%V_{out}$) is 50 ms. The default output voltage rise time ($0 - V_{out}$) is 50 ms. The softstart power up of the converter can be reconfigured using the PMBus commands.

Pre-Bias Start-up

The converter supports prebias. If the output terminal has a prebias voltage, the output voltage directly increases from the prebias voltage to the rated voltage after the converter starts. The following figure shows the typical waveform.



Figure 16: Pre-bias

Recommended Fuse

The converter has no internal fuse. To meet safety and regulatory requirements, a 30 A fuse is recommended.

NOTE

The fuse current should be 1.5 to 2 times the maximum operating current in actual use.

Recommend Reverse Polarity Protection Circuit

Reverse polarity protection is recommended under installation and cabling conditions where reverse polarity across the input may occur.

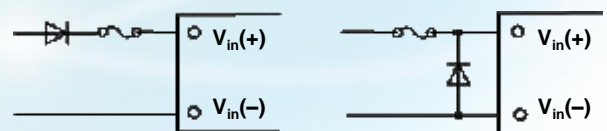

Figure 17: Recommend reverse polarity protection circuits

GDE20S12B/P

DC-DC Converter Technical Manual V1.4

Input Undervoltage Protection

The converter will shut down after the input voltage drops below the undervoltage protection threshold for shutdown. The converter will start to work again after the input voltage reaches the input undervoltage protection threshold for startup. For the Hysteresis, see the Protection characteristics.

Output Overcurrent Protection

The converter equipped with current limiting circuitry can provide protection from an output overload or short circuit condition. If the output current exceeds the output overcurrent protection set point, the converter enters hiccup mode. When the fault condition is removed, the converter will automatically restart.

Output Overvoltage Protection

When the voltage directly across the output pins exceeds the output overvoltage protection threshold, the converter will enter hiccup mode. When the fault condition is removed, the converter will automatically restart.

Overtemperature Protection

A temperature sensor on the converter senses the average temperature of the module. It protects the converter from being damaged at high temperatures. When the temperature exceeds the overtemperature protection threshold, the output will shut down. It will allow the converter to turn on again when the temperature of the sensed location falls by the value of Overtemperature Protection Hysteresis.

MTBF

The MTBF is calculated according to the Telcordia, SR332 Method 1 Case3.

EMC

For the acceptance standard, see the *DC-DC Converter EMC Acceptance Manual*.

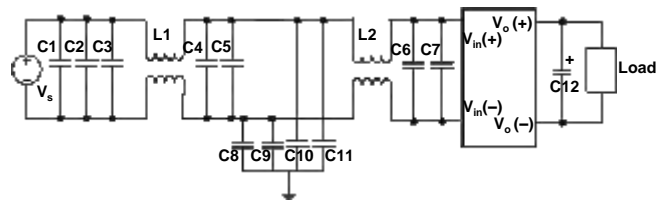

Figure 18: EMC test set-up diagram

C1, C2, C3, C4, C5: Surface mount device (SMD) ceramic capacitor (100 V/1000 nF/X7R/1210)

C6: SMD ceramic capacitor (100 V/100 nF/±10%/X7R/1206)

L1, L2: Common-mode inductor (single phase, 473 $\mu\text{H}/\pm 25\%/14 \text{ A}/1 \text{ mm} \times 25.4 \text{ mm} \times 12.7 \text{ mm}$ [0.04 in. \times 1.0 in. \times 0.5 in.]). The chip component with the same specifications can also be used.

C8, C9, C10, C11: High-pressure resistant chip ceramic capacitor (100 nF/1000 V/X7R/2220). meeting the 1 kV pressure resistance requirement.

C7: Electrolytic capacitor (100 $\mu\text{F}/100 \text{ V}$)

C12: Electrolytic capacitor (440 $\mu\text{F}/25 \text{ V}$)

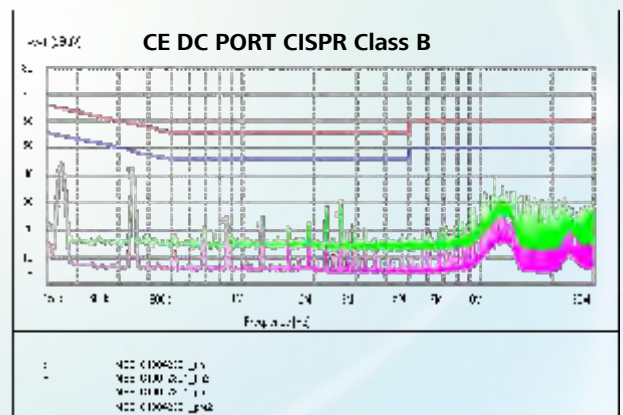

Figure 19: EMC test result

GDE20S12B/P

DC-DC Converter Technical Manual V1.4

Pin Description

Pin	Description
On/Off	See "Remote On/Off"
PMBus_SCL and PMBus_SDA	PMUus communications port (connects to the I2C bus, 3.3 V)
PMBus_CTL	See "CTL Secondary Enable Control"
SA1, SA0, and SGND	See "Address Definition"
ISHARE and SYNC	If only one converter is used, leave the two pins open. If two converters are connected parallel, connect ISHARE1 to ISHARE1 and SYNC1 to SYNC2
PMBus_ALT	Connect with the main ALT directly

Definition of I2C/PMBus Setting-up Time and Holding Time

t_{set} is the duration for which SDA keeps its value unchanged before SCL increases.

t_{hold} is the duration for which SDA keeps its value unchanged after SCL decreases.

The communication will fail if the time is not consistent with the specifications.

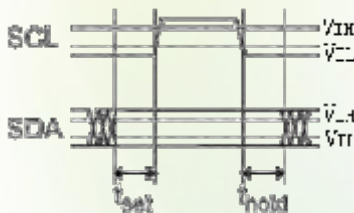

Parallel Operation

The products can be paralleled if external oring diodes or oring Mosfets are used in series with the output.

For further information please contact your local sales representative.

NOTE

If two converters are connected in parallel, note the following:

1. Within 2 seconds after the converters start, the load current must not be less than or equal to 20 A.
2. The address of each converter is unique.

PCB Layout Consideration

Separate power trace and signal trace to avoid mutual interference.

Address Definition

The resistances of R_{SA0} and R_{SA1} are different (resistors with 1% tolerance are recommended). The SA0 and SA1 pins correspond to different voltages and numbers. Set an PMBus address by using the formula below. The converter supports dynamic address detection.

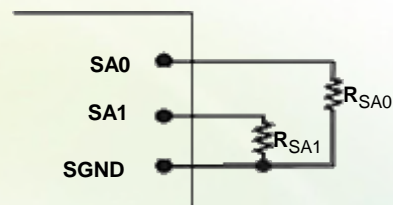

Table 2 Address configuration

R_{SA0}/R_{SA1} [k Ω]	SA0/SA1 [V]	SA0/SA1
0 - 15	0 - 0.165	0
22	0.198 - 0.242	1
30	0.270 - 0.330	2
51	0.459 - 0.561	3
80.6	0.725 - 0.887	4
113	1.017 - 1.243	5
150	1.350 - 1.650	6
> 220 (including left open)	1.980 - 2.500	7

The PMBus address is determined by the following formula:

$$PMBusAddress = 12 \times SA1No. + SA0No.$$

Theoretically, this formula can generate a maximum of 64 PMBus address, but address 0 and address 12 are prohibited.

For details, refer to PMBus Revision 1.0.

PMBus Commands

The products are PMBus compliant. The following table lists the implemented PMBus commands. For more detailed information see PMBus Power System Management Protocol Specification; Part I -General Requirements, Transport and Electrical Interface and PMBus Power System Management Protocol; Part II - Command Language.

Table 3 Common commands

Designation	Cmd	Impl
Control Commands		
OPERATION	01h	Yes
CLEAR_FAULTS	03h	Yes
RESTORE_DEFAULT_ALL	12h	Yes
STORE_USER_ALL	15h	Yes
RESTORE_USER_ALL	16h	Yes
CAPABILITY	19h	Yes
Output Commands		
VOUT_MODE	20h	Yes
VOUT_COMMAND	21h	Yes
VOUT_TRIM	22h	Yes
FREQUENCY_SWITCH	33h	Yes
Fault Alarm Commands		
VOUT_OV_WARN_LIMIT	42h	Yes
VOUT_UV_WARN_LIMIT	43h	Yes
IOUT_OC_WARN_LIMIT	4Ah	Yes
OT_WARN_LIMIT	51h	Yes
VIN_OV_WARN_LIMIT	57h	Yes
VIN_UV_WARN_LIMIT	58h	Yes
Time Sequence Setting Commands		
TON_DELAY	60h	Yes
TON_RISE	61h	Yes
Status Commands		
STATUS_BYTE	78h	Yes
STATUS_WORD	79h	Yes
STATUS_VOUT	7Ah	Yes
STATUS_IOUT	7Bh	Yes
STATUS_INPUT	7Ch	Yes

Designation	Cmd	Impl
STATUS_TEMPERATURE	7Dh	Yes
STATUS_CML	7Eh	Yes
Monitoring Commands		
READ_VIN	88h	Yes
READ_VOUT	8Bh	Yes
READ_IOUT	8Ch	Yes
READ_TEMPERATURE_1	8Dh	Yes
READ_TEMPERATURE_2	8Eh	Yes
READ_TEMPERATURE_3	8Fh	Yes
READ_DUTY_CYCLE	94h	Yes
READ_FREQUENCY	95h	Yes
READ_POUT	96h	Yes
Identification Commands		
PMBus_REVISION	98h	Yes
MFR_ID	99h	Yes
MFR_MODEL	9Ah	Yes
MFR_REVISION	9Bh	Yes
MFR_LOCATION	9Ch	Yes
MFR_DATE	9Dh	Yes
Customized Commands		
MFR_SOFT_VERSION	F3h	Yes
PMBus_CMD_MFR_ISHARE_ENABLE	F8h	Yes
PMBus_CMD_MFR_BAR_CODE_FIRSTHALF	FAh	Yes
PMBus_CMD_MFR_BAR_CODE_SECONDDHALF	FBh	Yes
PMBus_CMD_MFR_DEVICE_ID	FDh	Yes
MFR_SOFT_VERSION	F3h	Yes



NOTE

1. Cmd is short for Command.
2. Impl is short for Implemented.

GDE20S12B/P

DC-DC Converter Technical Manual V1.4

Qualification Testing

Parameter	Units	Condition
High Accelerated Life Test (HALT)	4	Lowest operating temperature: -60°C (-76°F); highest operating temperature: 120°C (248°F); vibration limit: 40 G
Proof Of Screen (POS)	4	80 temperature cycles; 50% vibration limit stress: 20 G
High Accelerated Stress Audit (HASA)	16	4 temperature cycles; 50% vibration limit stress: 20 G
Thermal Shock	16	700 temperature cycles between -40°C (-40°F) and +125°C (+257°F) with the temperature change rate of 20°C (68°F) per minute Lasting for 30 minutes both at -40°C (-40°F) and +125°C (+257°F)
Temperature Humidity Bias	8	85°C (185°F); 85% RH; 1000 operating hours under lowest load power
High Temperature Operation Life (HTOL)	8	Rated input voltage; 40°C(104°F) to 60°C(140°F) ; 1000 operating hours under 50% - 80% load power. Ensure the temperature at the thermal test point between 90°C (194°F) and 100°C(212°F).

Thermal Consideration

Thermal Test Point

Sufficient airflow should be provided to ensure reliable operating of the converter. Therefore, thermal components are mounted on the top surface of the converter to dissipate heat to the surrounding environment by conduction, convection and radiation. Proper airflow can be verified by measuring the temperature at the thermal test point.

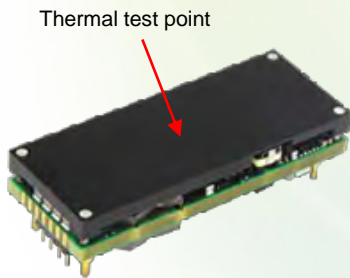

Figure 20: Thermal test point

NOTE

The temperature at the thermal test point on the converter can not exceed 105°C (221°F). Otherwise, the converter will be protected against overtemperature and will not operate properly.

Power Dissipation

The converter power dissipation is calculated based on efficiency. The following formula reflects the relationship between the consumed power (P_d), efficiency (η), and output power (P_o): $P_d = P_o(1-\eta)/\eta$

Thermal Testing Setup

Test board: D x W=254mm x 254mm, 2oz, 4 layers, cross section of the wind tunnel: 800mm x 45mm.

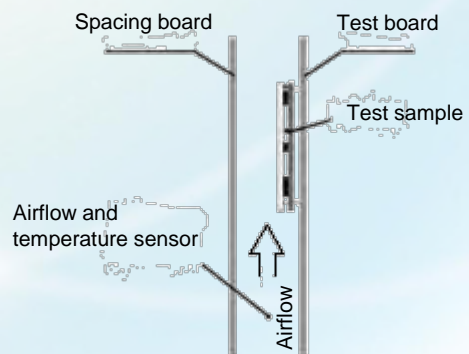

Figure 21: Wind tunnel test setup

GDE20S12B/P

DC-DC Converter Technical Manual V1.4

Mechanical Consideration

Installation

Although the converter can be mounted in any direction, free airflow must be taken.

Soldering

The converter is compatible with standard wave soldering techniques. When wave soldering, the converter pins should be preheated for 20 - 30 seconds at 110°C (230°F) , and wave soldered at 260°C (500°F) for less than 10 seconds.

When hand soldering, the iron temperature should be maintained at 425°C (797°F) and applied to the converter pins for less than 5 seconds.

The converter can be rinsed using the isopropyl alcohol (IPA) solvent or other proper solvents.

HUAWEI TECHNOLOGIES CO., LTD.
Huawei Industrial Base Bantian Longgang
Shenzhen 518129
People's Republic of China
www.huawei.com